

SÉRIE DIM 700

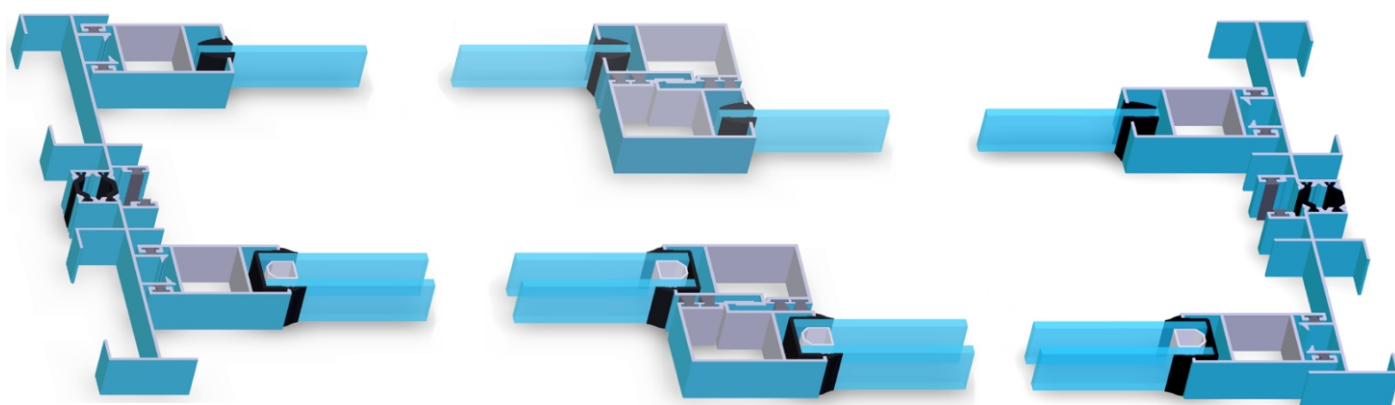

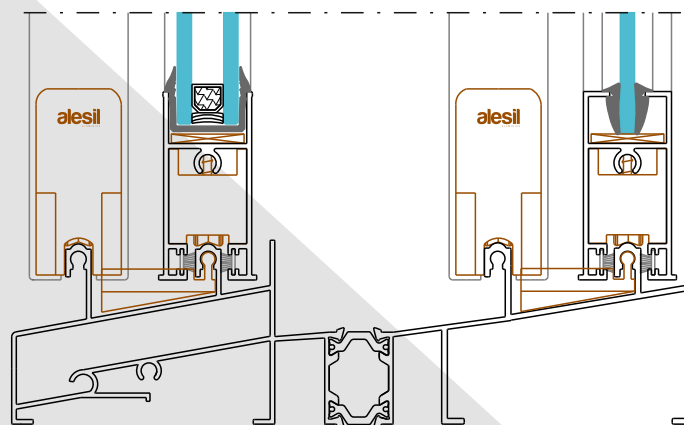

NORMA EN 14351-1:2006

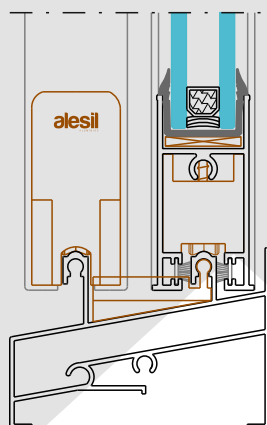

CAIXILHO SIMPLES

CAIXILHO DUPLO

Vão Dimensão L x H	Janela 2 fls 1230 x 1480	Porta 2 fls 1500 x 2200	Janela 2 fls 1230 x 1480	Porta 2 fls 1500 x 2200
	Vidro Utilizado 4 / 12 / 4		Vidro Utilizado Ext: 4 / 12 / 4 + Int: 4	



Permeabilidade ao Ar
(UN-EN 1026:2000)

Classe 3

Certificado 173637

Classe 3

Certificado 173636

Classe 3

Certificado 173633

Classe 3

Certificado 173632



Permeabilidade à Água
(UN-EN 1027:2000)

Classe 7A

Certificado 173637

Classe 7A

Certificado 173636

Classe 8A

Certificado 173633

Classe 8A

Certificado 173632



Resistência ao Vento
(UN-EN 12211:2000)

Classe C5

Certificado 173637

Classe C1

Certificado 173636

Classe C4

Certificado 173633

Classe B1

Certificado 173632



Transmissão Térmica
(UN-EN 12567-1:2002)

$U_{s,t}$ (U_w)

4,2 w / (m² k)

Certificado 173639

4,2 w / (m² k)

Certificado 173639

2,7 w / (m² k)

Certificado 173635

2,7 w / (m² k)

Certificado 173635



Atenuação Acústica
(UN-EN 140-3:1995)

R_w (C;Ctr)

28 (-1; -3) db

Certificado 173638

28 (-1; -3) db

Certificado 173638

43 (-2; -7) db

Certificado 173634

43 (-2; -7) db

Certificado 173634

DIM 700

908 A
Soleira Simples

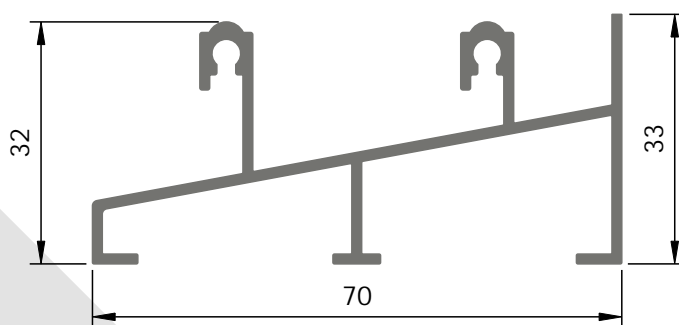

908
Soleira Dupla

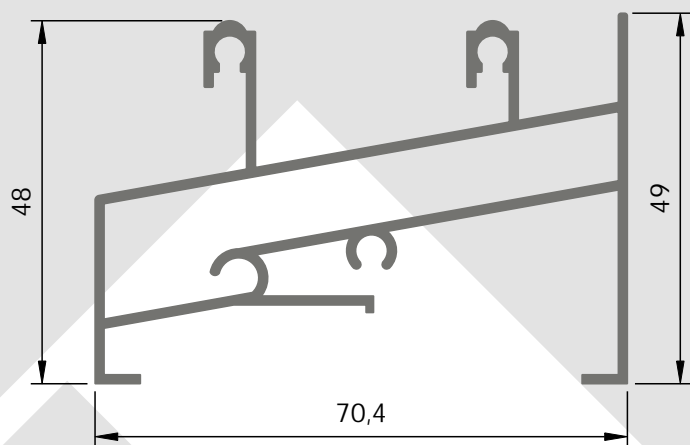

910
Padiieira

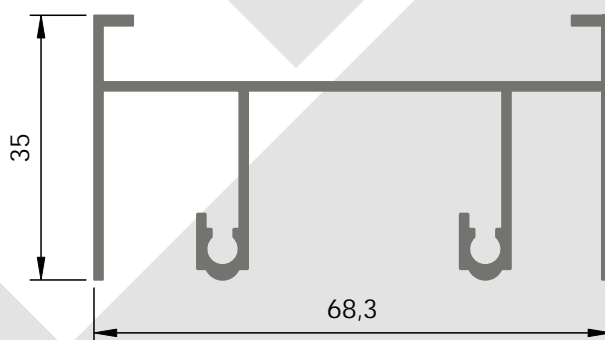

911
Ombreira

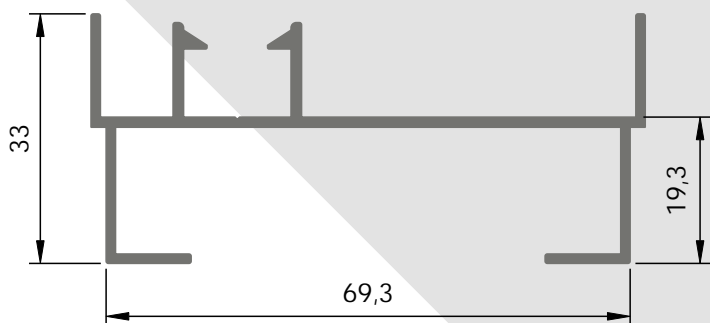

1

DIM 700

918 A

Soleira de Ligação
à Série BP

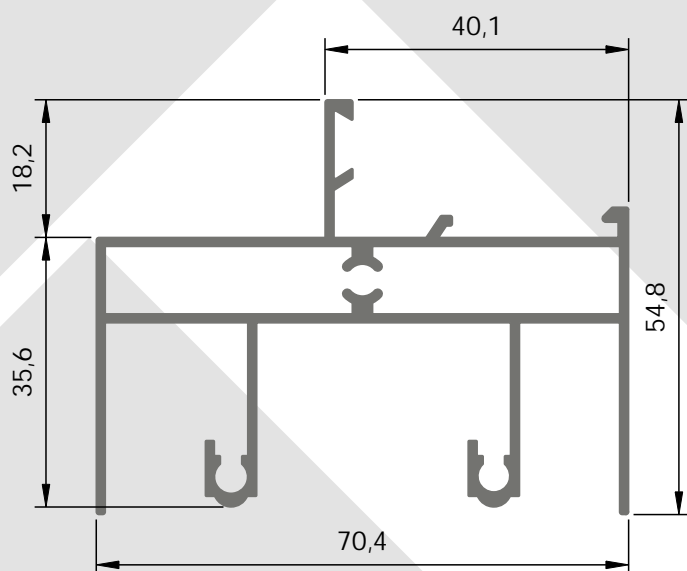
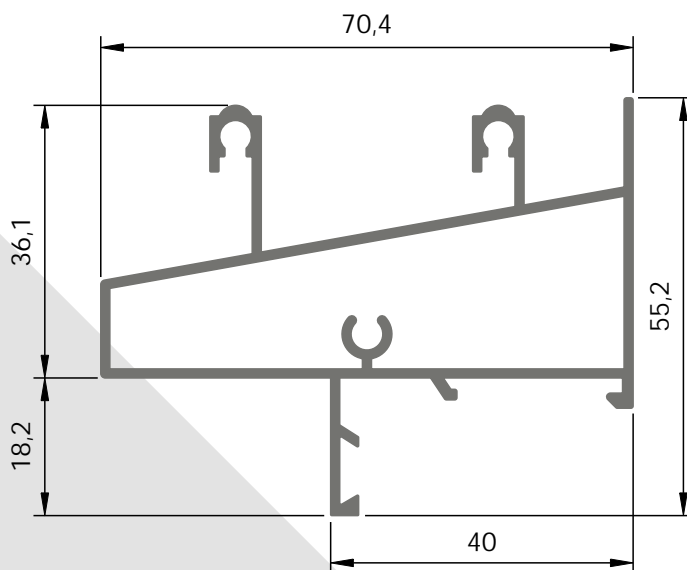

917 A

Padieira de Ligação
à Série BP

916

Perfil de Ligação
p/ 4 Folhas

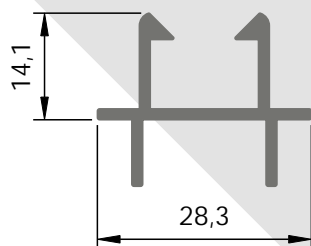

909-L CLI

Aro de Ligação à Série BP

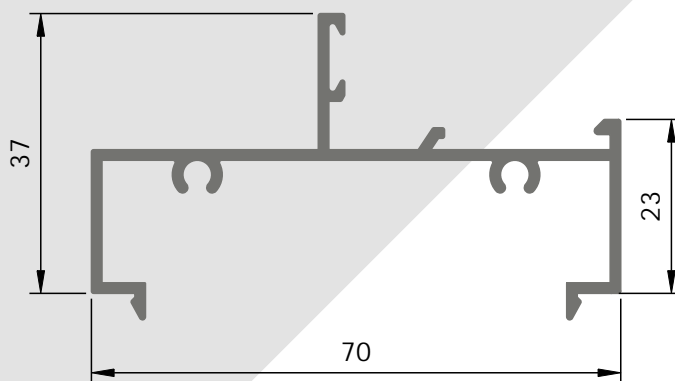

DIM 700

TC-01

Padieira de 3 Vias

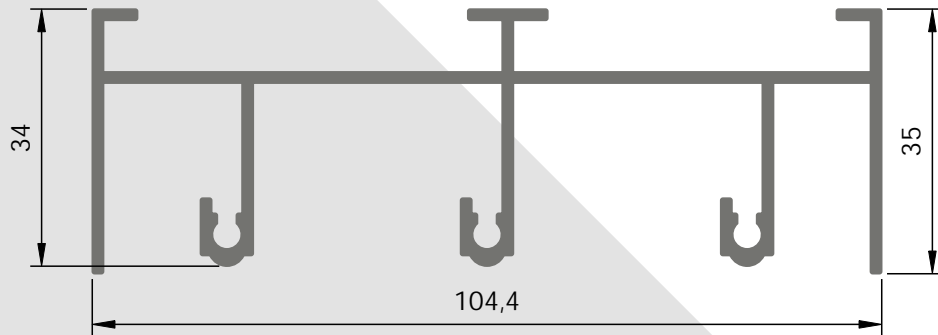

TC-02

Soleira de 3 Vias

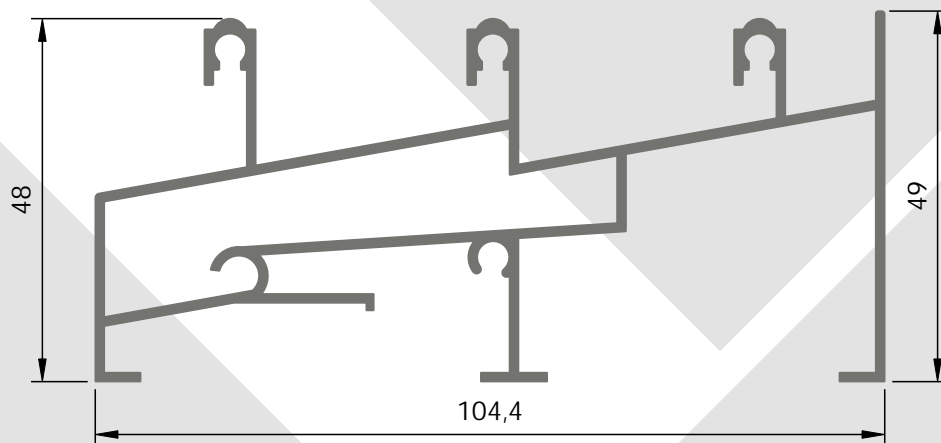

TC-03

Ombreira de 3 Vias

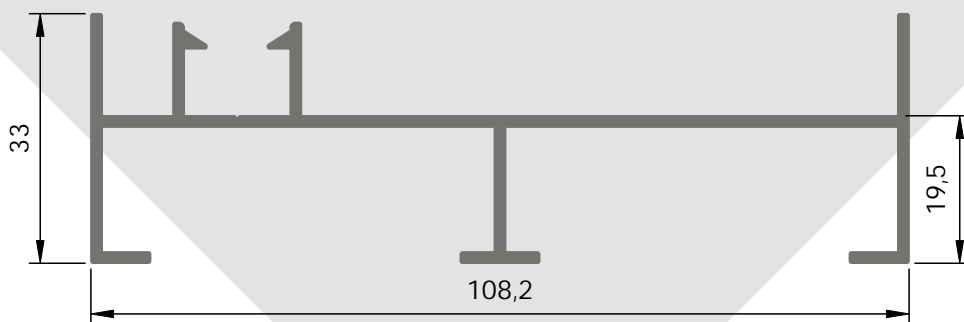

DIM 700

TC-05 A

Soleira Dupla c/ Ruptura Térmica

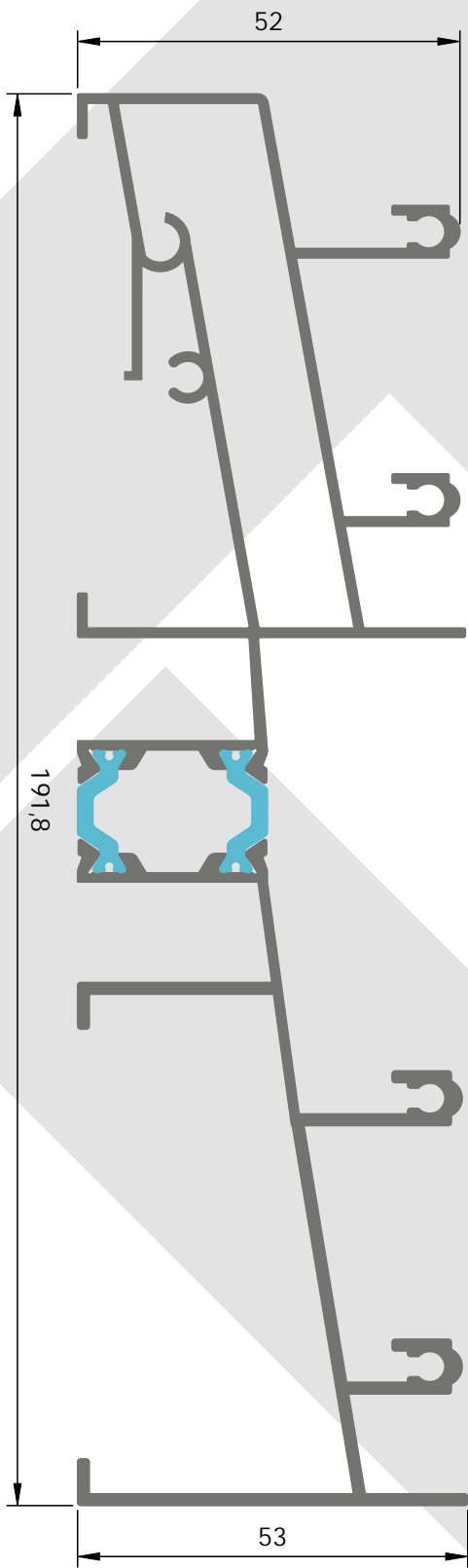

TC-06

Ombreira Dupla c/ Ruptura Térmica

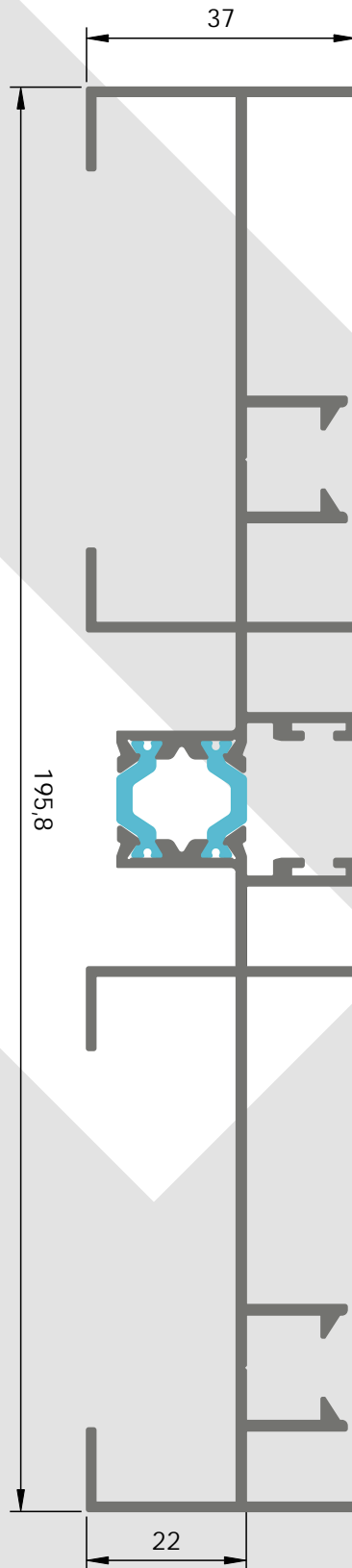

TC-07

Padieira Dupla

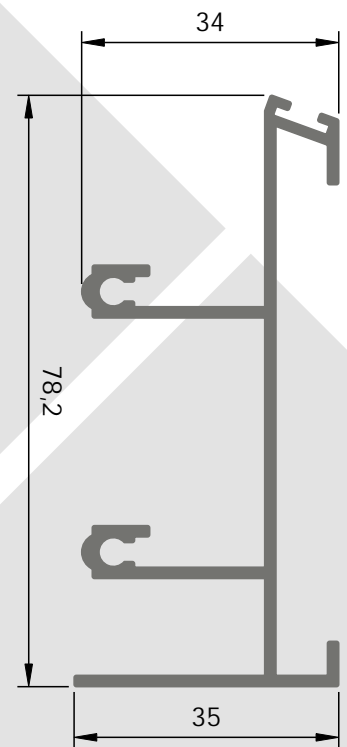

DIM 700

28-169

Soleira Dupla

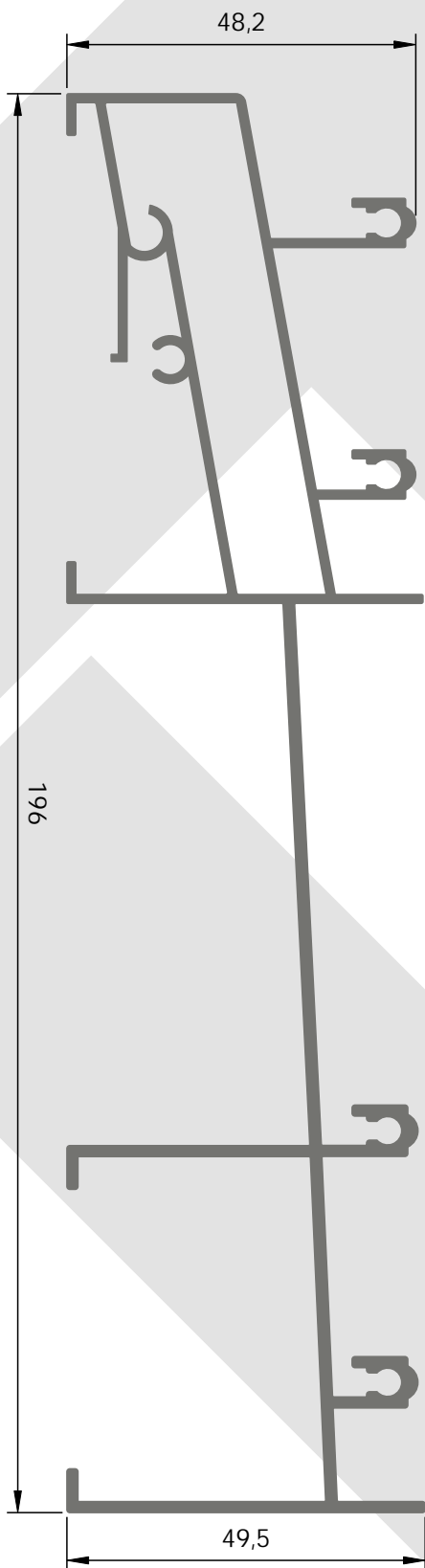

28-170

Ombreira Dupla

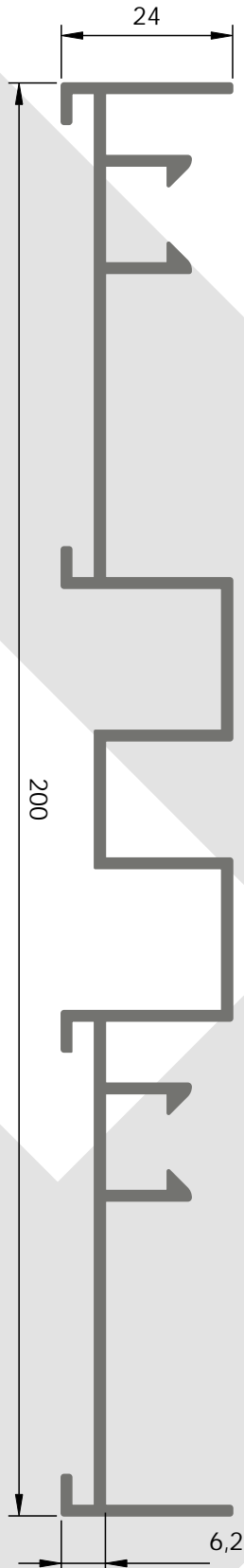

883

Padieira Dupla

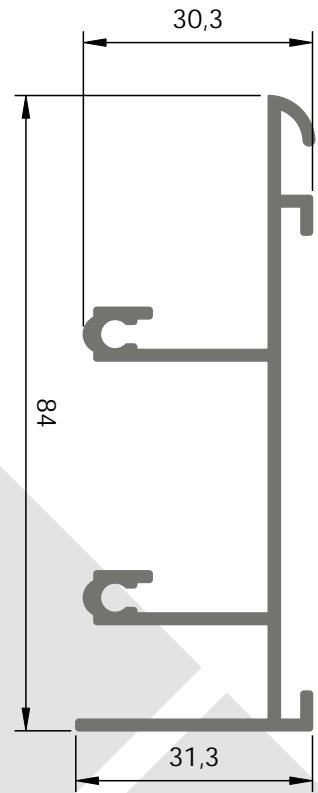

V-25

Calha de Estore

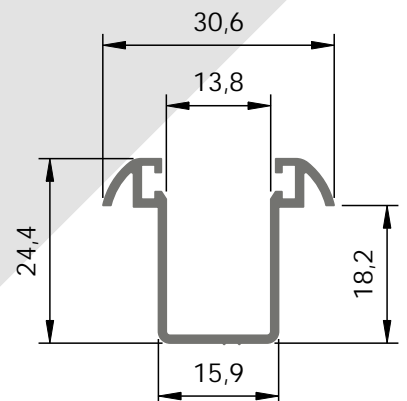

5

DIM 700

912

Móvel Central VS

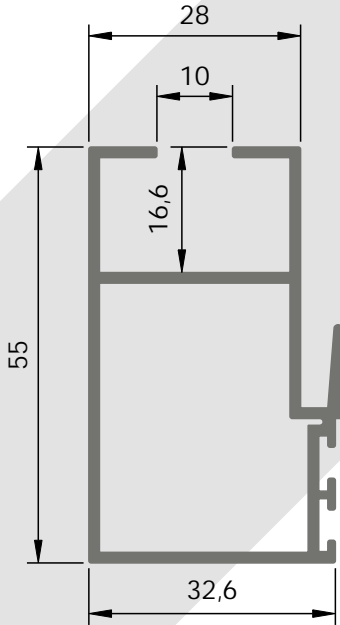

997 L

Móvel Lateral VS

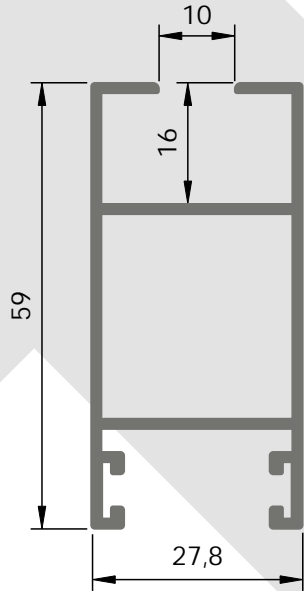

528

Móvel Sup/Inf VS

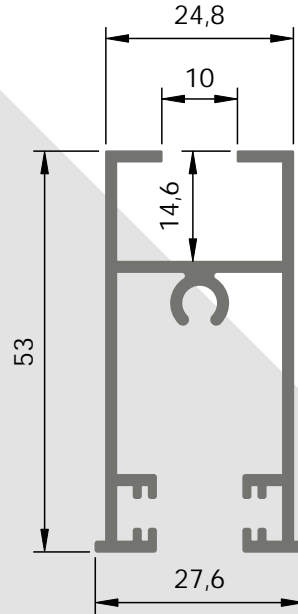

4698

Travessa VS

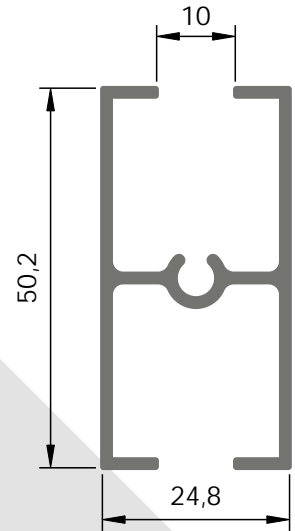

912 CLI-C

Móvel Central VD

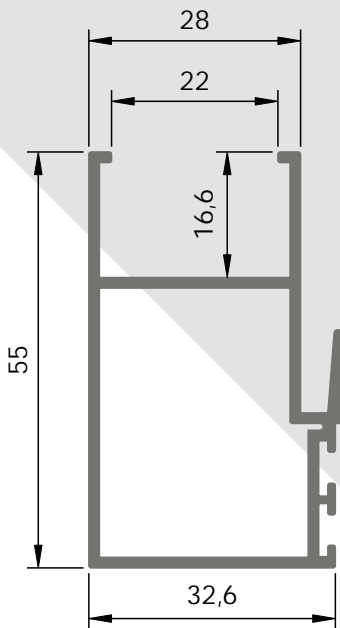

997 L-CLI

Móvel Lateral VD

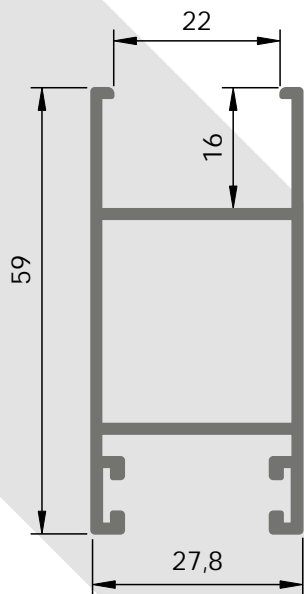

528 CLI

Móvel Sup/Inf VD

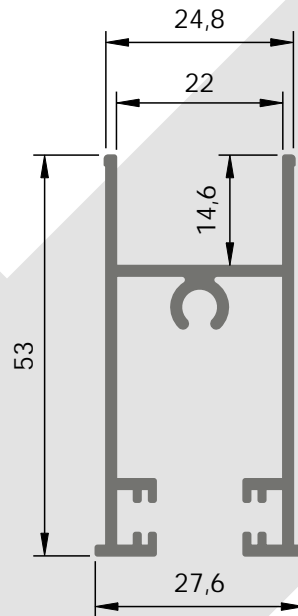

4698 CLI

Travessa VD

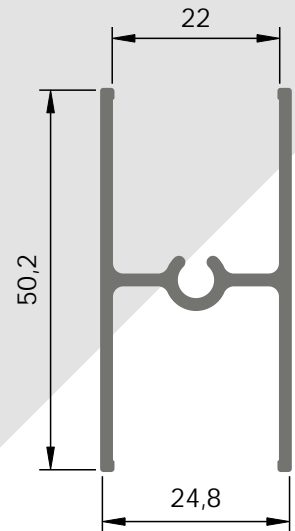

DIM 700

4699

Travessa VS

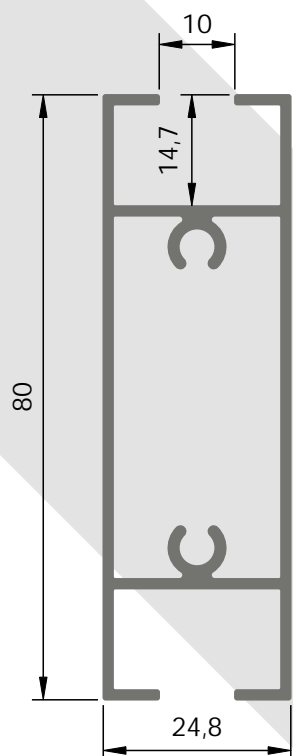

4699 CLI

Travessa VD

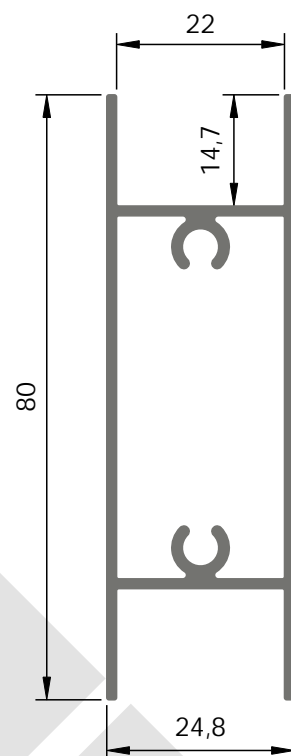

4700

Móvel Inferior VS

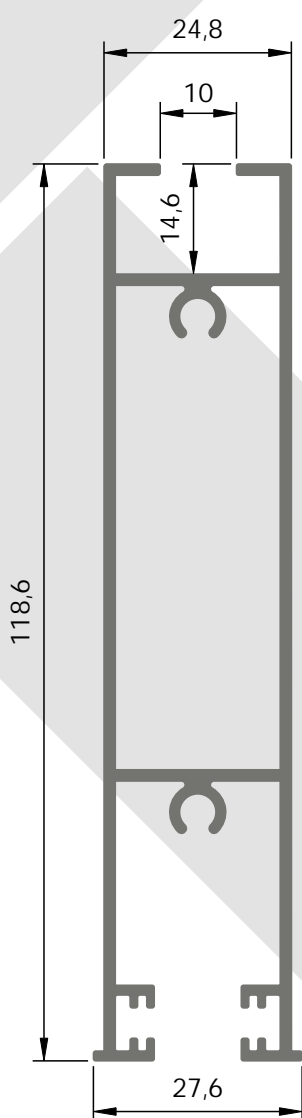

4700 CLI-C

Móvel Inferior VD

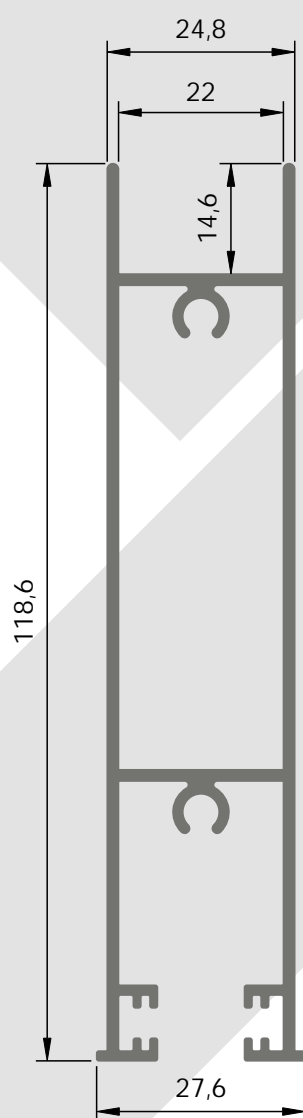

DIM 700

PORMENORES DE MONTAGEM

JANELA DE 2 FOLHAS

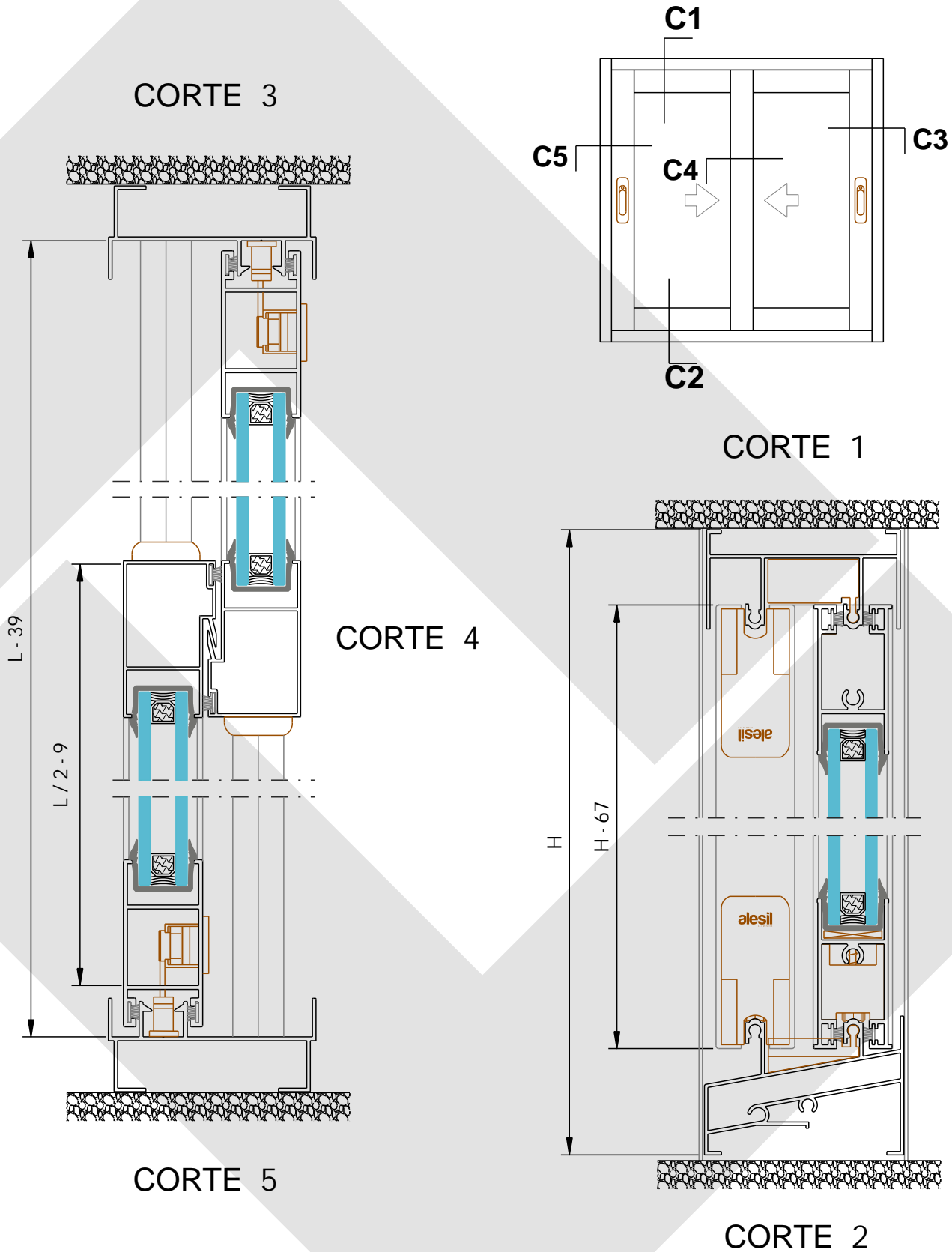

Estas medidas de corte são de carácter informativo

DIM 700





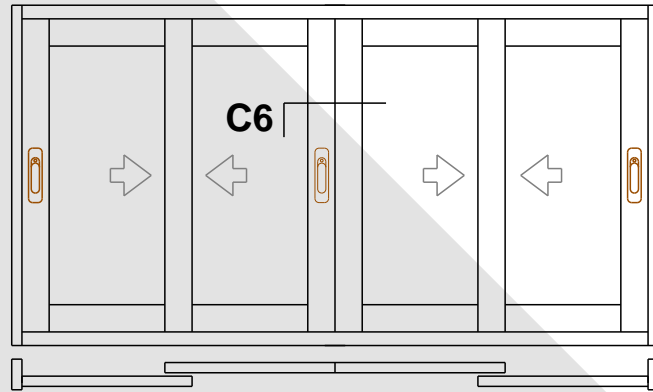



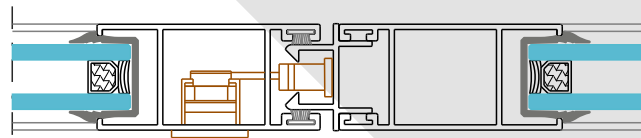

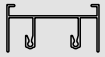
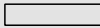
PORMENORES DE MONTAGEM

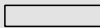
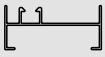
JANELA DE 4 FOLHAS

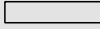

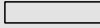
CORTE 6



Des.	Ref.	Descrição	Corte	Qt.	Medida
	910	Padieira		1	L-39
	908	Soleira		1	L-39
	502C	Ombreira		2	H
	528-CLI	Travessa de Vidro Duplo		4	L/2-9
	997-LCLI	Folha Lateral Vidro Duplo		2	H-67
	912-CLI	Folha Central Vidro Duplo		2	H-67
	916	União 4 folhas		1	H-67

Estas medidas de corte são de carácter informativo

DIM 700

PORMENORES DE MONTAGEM

JANELA DE 2 FOLHAS DUPLA

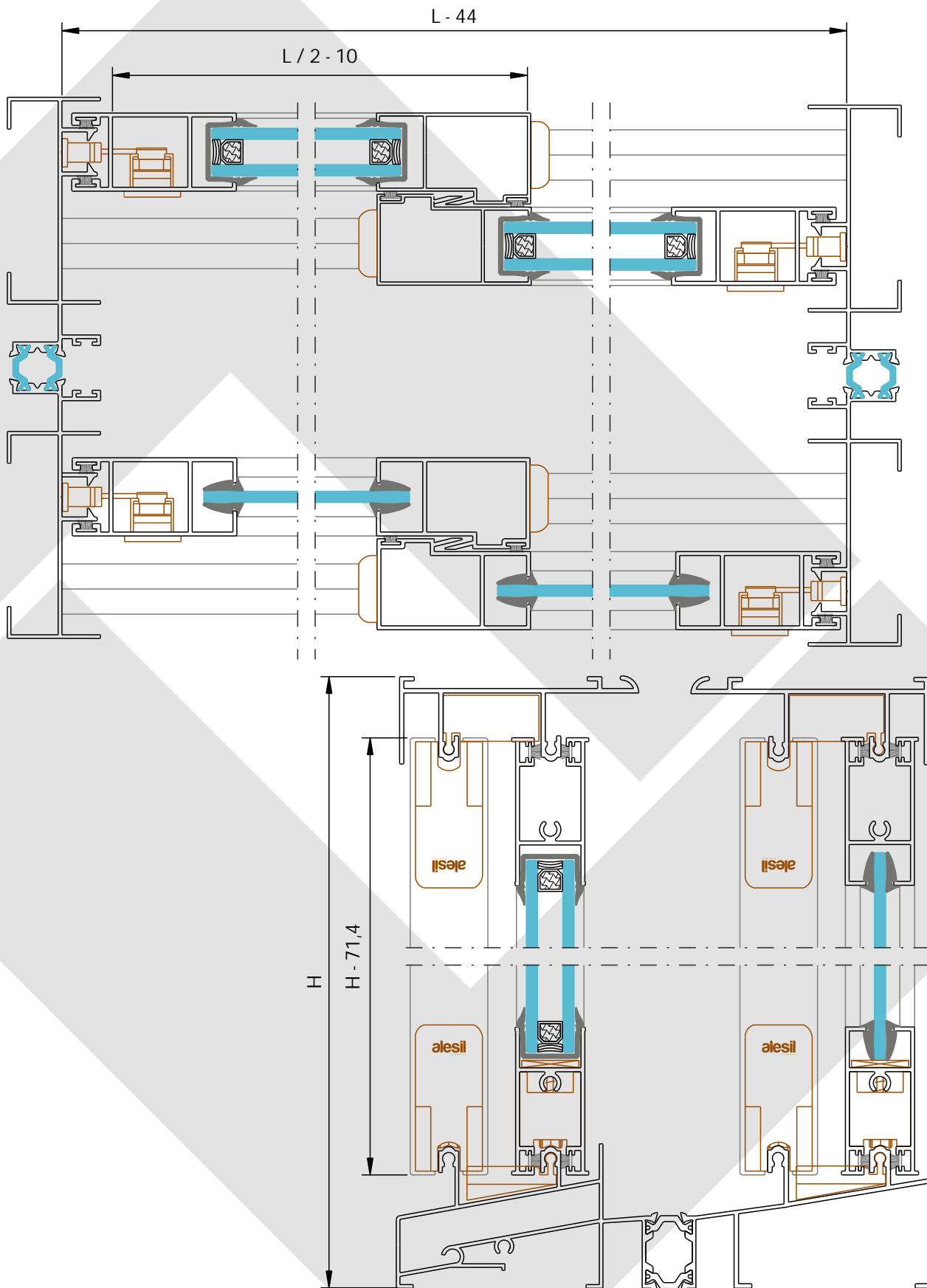

Estas medidas de corte são de carácter informativo

DIM 700

PORMENORES DE MONTAGEM

JANELA DE 2 FOLHAS DUPLA

L - 15

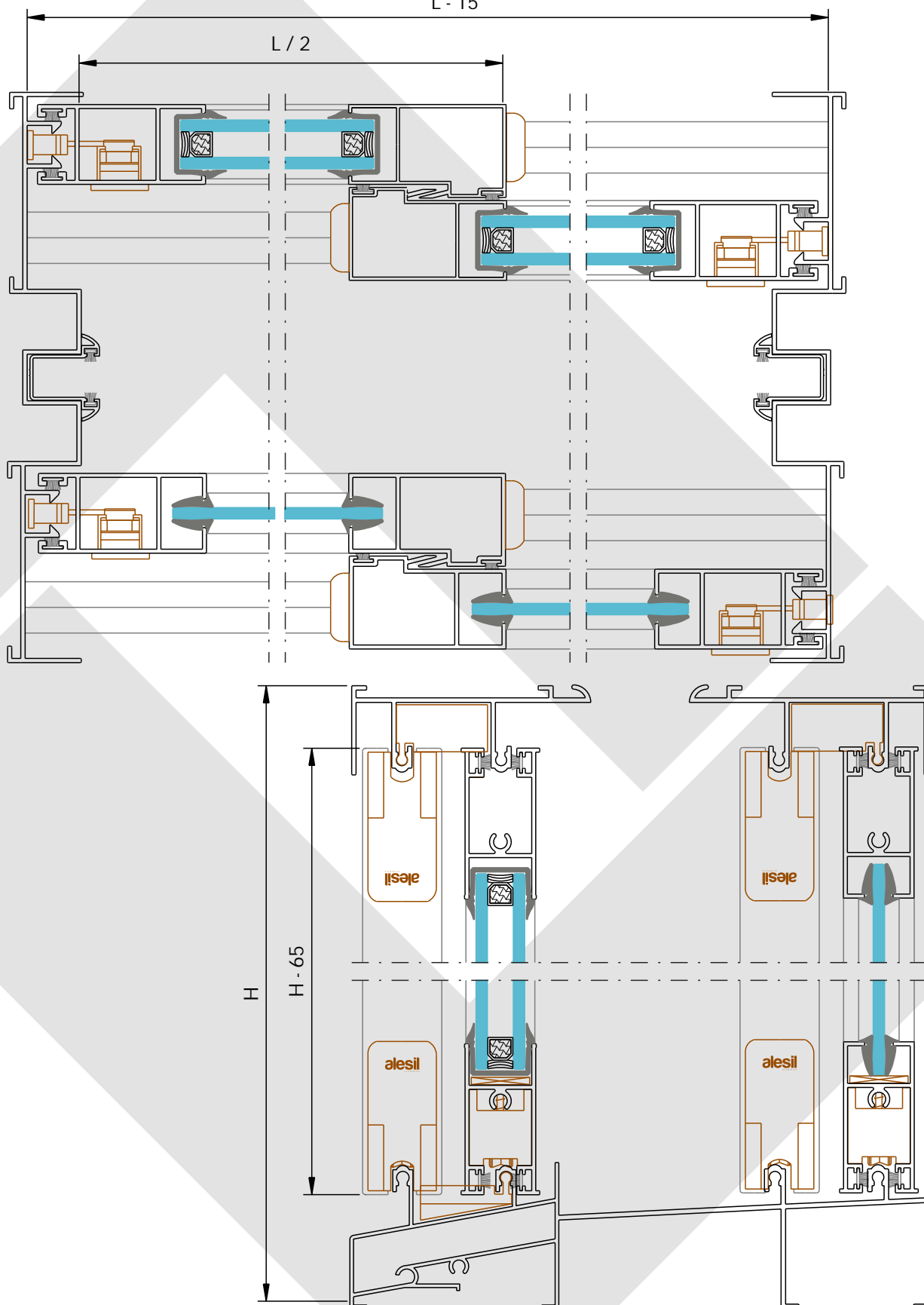

Estas medidas de corte são de carácter informativo

Escala 1:2

ed. 001

DIM 700

ACESSÓRIOS

Características



CÓDIGO: **G90.FEC**

DESCRIÇÃO: **Fecho embutir com e sem travão**

UNID. VENDA: **Unidade**

ACABAMENTOS: **Alumínio**

APLICAÇÃO: **997L, 997LCLI**



CÓDIGO: **ASA**

DESCRIÇÃO: **Asa para fecho DIM700**

UNID. VENDA: **Unidade**

ACABAMENTOS: **Zamak**

APLICAÇÃO:



CÓDIGO: **G90.GUIAS**

DESCRIÇÃO: **Kit guias Dim700**

UNID. VENDA: **Unidade**

ACABAMENTOS: **PVC**

APLICAÇÃO: **912, 912 CLI-C**

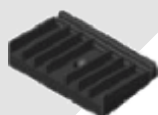

CÓDIGO: **G90.CRV.1**

DESCRIÇÃO: **Corta vento inferior DIM700**

UNID. VENDA: **Unidade**

ACABAMENTOS: **EPDM**

APLICAÇÃO: **908, 908A, 918A, TC-02, TC-05A, 28-169**

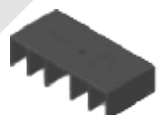

CÓDIGO: **G90.CRV.2**

DESCRIÇÃO: **Corta vento superior DIM700**

UNID. VENDA: **Unidade**

ACABAMENTOS: **EPDM**

APLICAÇÃO: **910, 917A, TC-01, TC-07, 883**

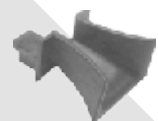

CÓDIGO: **G90.TOPO1**

DESCRIÇÃO: **Topo DIM700 RPT**

UNID. VENDA: **Unidade**

ACABAMENTOS: **PVC**

APLICAÇÃO: **TC-06**



CÓDIGO: **G90.EST.1**

DESCRIÇÃO: **Junta**

UNID. VENDA: **Unidade**

ACABAMENTOS:

APLICAÇÃO: **910**



CÓDIGO: **G90.EST.3**

DESCRIÇÃO: **Junta**

UNID. VENDA: **Unidade**

ACABAMENTOS:

APLICAÇÃO: **TC-05A**



CÓDIGO: **G90.EST.2**

DESCRIÇÃO: **Junta**

UNID. VENDA: **Unidade**

ACABAMENTOS:

APLICAÇÃO: **908**



CÓDIGO: **G90.ROL.D**

DESCRIÇÃO: **Rolamento Nylon DIM 700 duplo**

UNID. VENDA: **Unidade**

ACABAMENTOS: **Nylon**

APLICAÇÃO: **4700, 4700 CLI-C**



CÓDIGO: **G90.ROL.S**

DESCRIÇÃO: **Rolamento Nylon DIM 700 simples**

UNID. VENDA: **Unidade**

ACABAMENTOS: **Nylon**

APLICAÇÃO: **528, 528 CLI**