

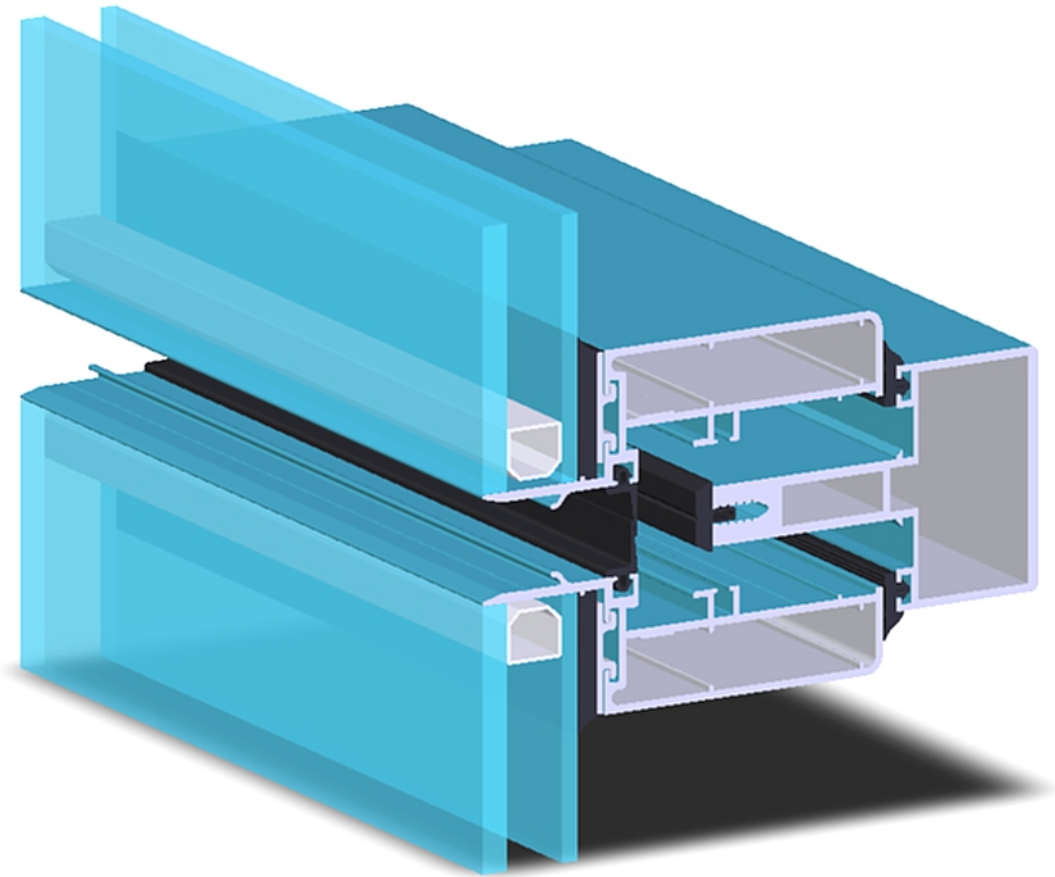

alesil
ALUMÍNIOS



FD

SÉRIE FD

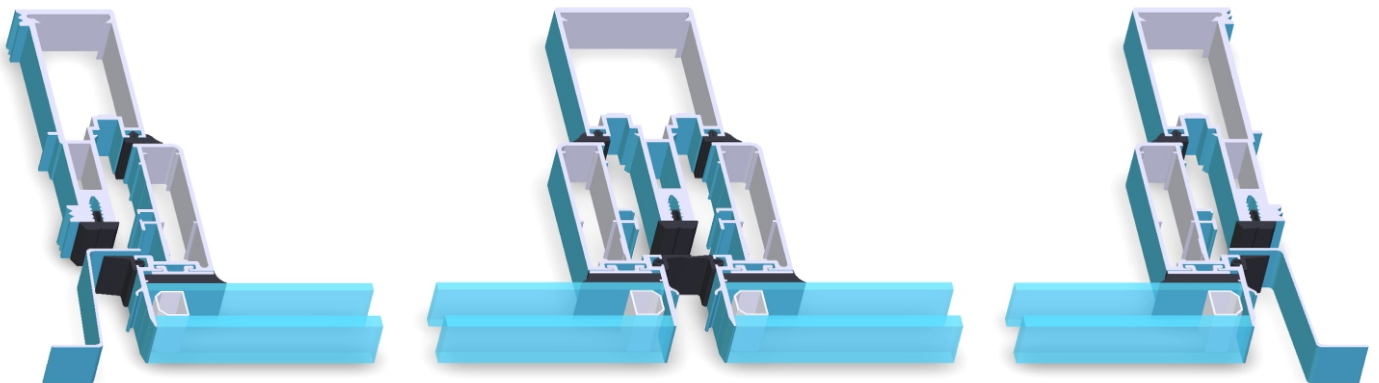

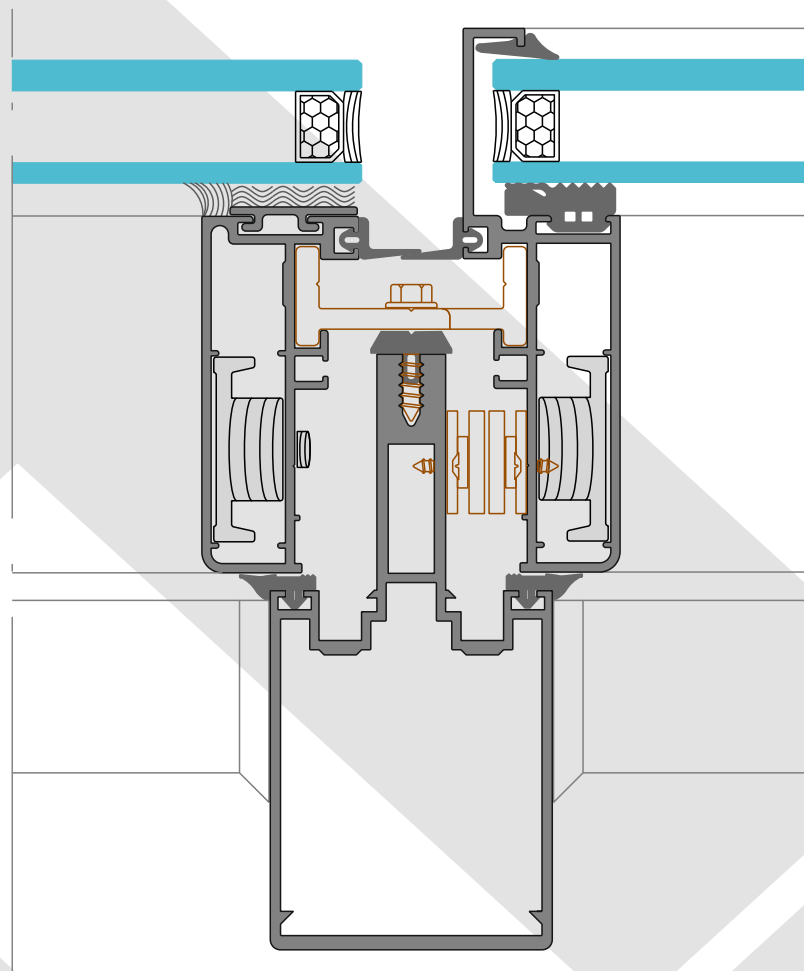
SISTEMA DE FACHADAS
VEC - VEP - CORTINA - TH - SEM BITE

- Sistemas de fachada com ruptura térmica, estruturais e semi-estruturais para novos conceitos de arquitectura.
- Fachadas de muro estrutural com tripla estanquidade, com quadros que conferem superfícies planas sem vista exterior de alumínio.
- Sistema concebido de acordo com as mais rígidas especificações de qualidade, por forma a garantir uma perfeita estanquidade à água e a um completo isolamento térmico e acústico.
- Montantes e travessas com 55mm e 65mm de elevada resistência mecânica permitindo vencer elevados momentos de inércia.
- Possibilidade de construções mistas com sistemas de batente com e sem ruptura térmica.
- Enchimentos de vidros até 45mm de espessura na fachada tradicional e até 30mm nas fachadas estruturais.

FD - CORTINA

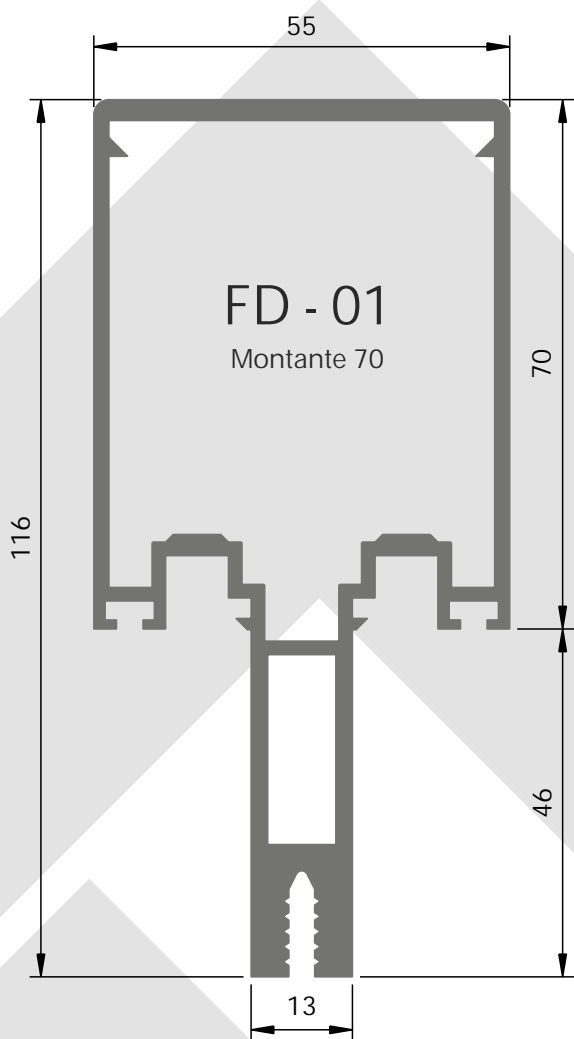

FD - 21
Montante 100

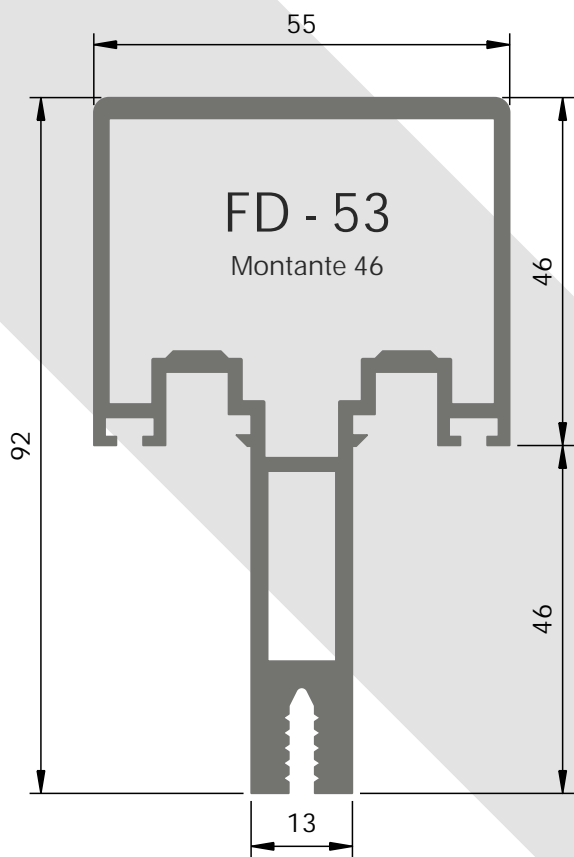
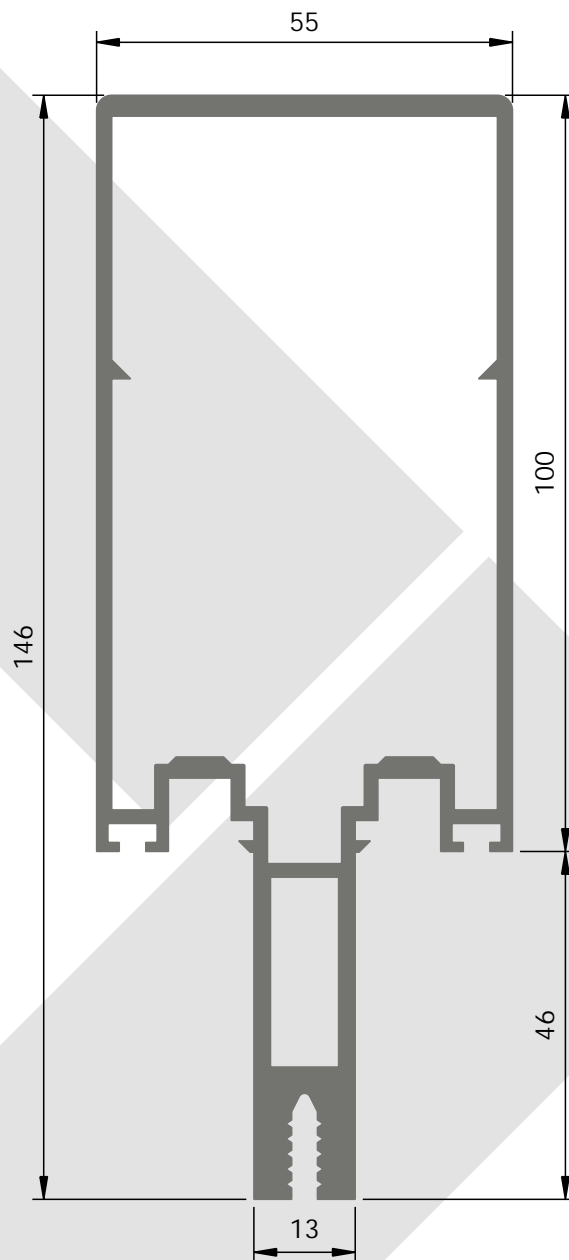

FD - CORTINA

FD - 20

Montante 125

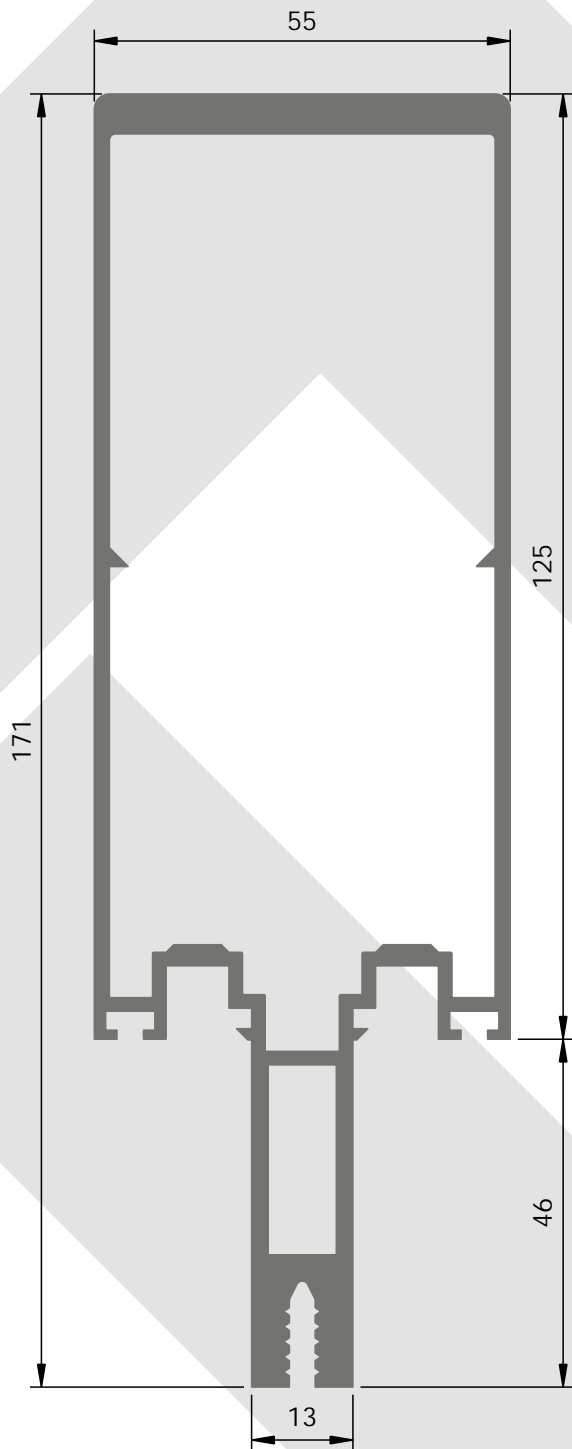

FD - 22

Montante 150

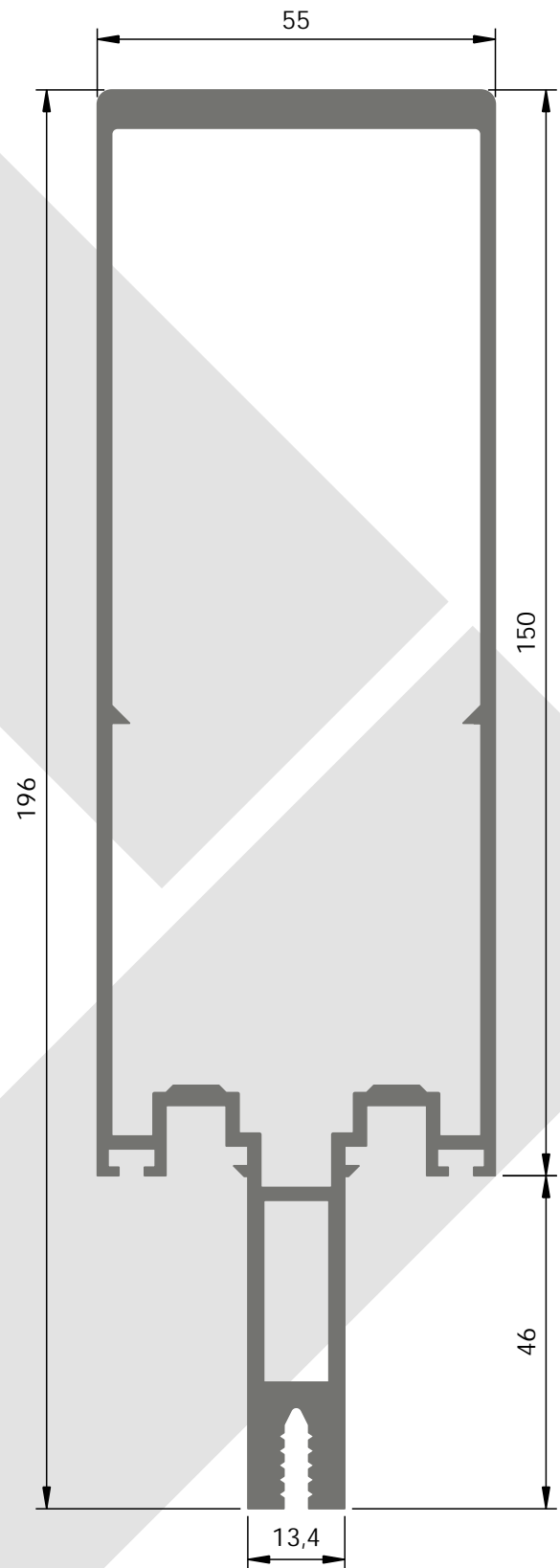

FD - CORTINA

FD - 26

Montante 70
P/ Junta de Dilatação

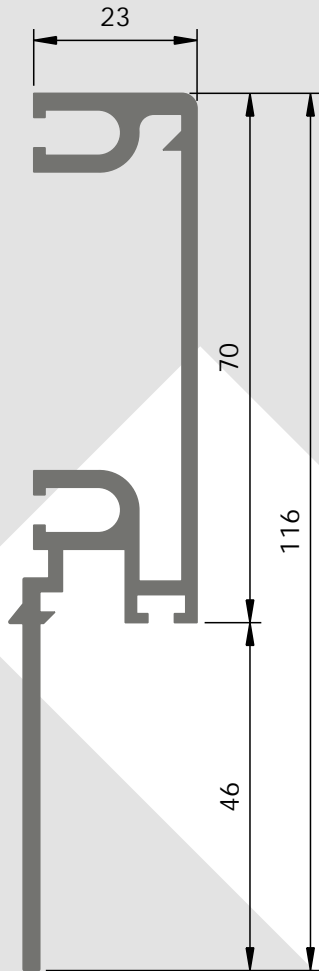

FD - 27

Perfil
P/ Junta de Dilatação

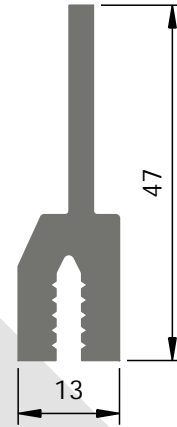

B.30x2

Perfil

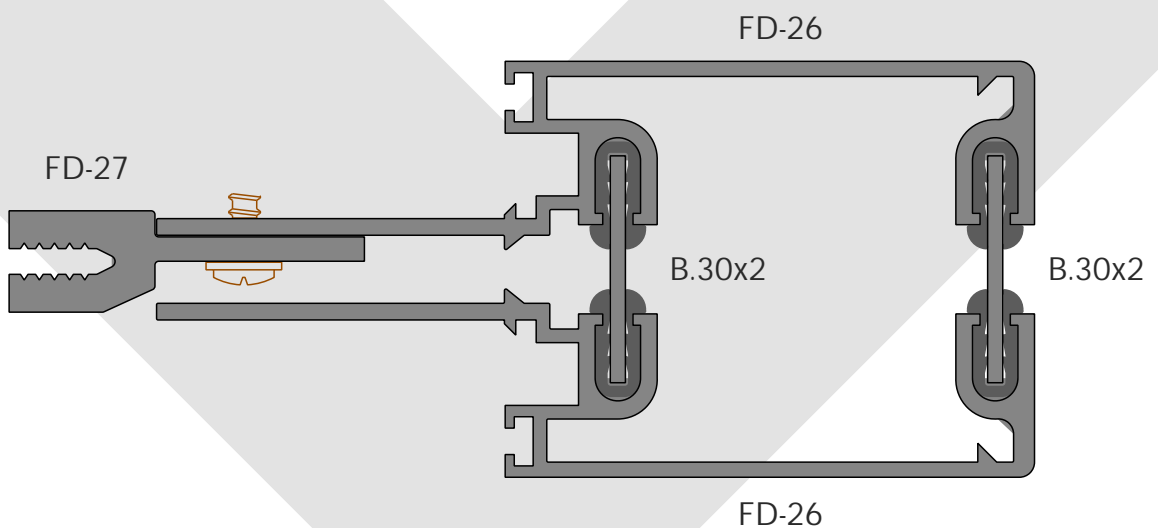
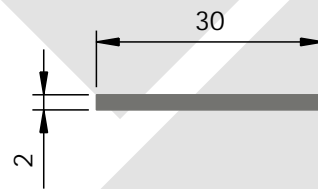

FD - CORTINA

FD - 23

Travessa 15

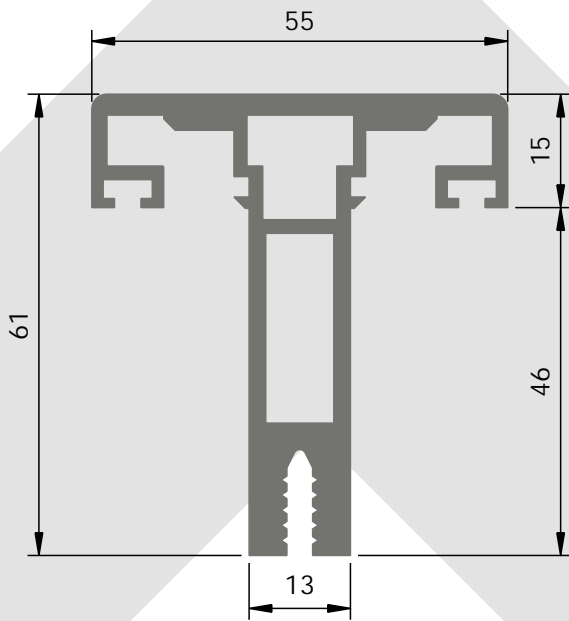

FD - 02

Travessa 36

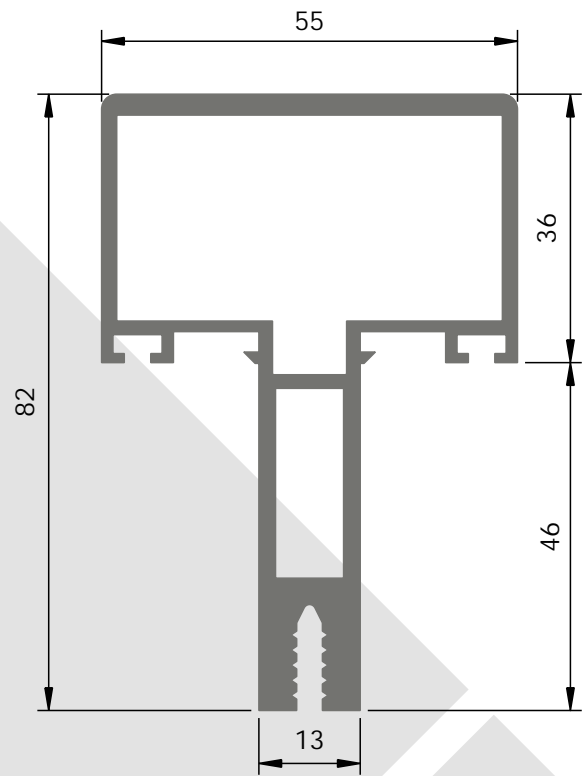

FD - 03

Contracapa

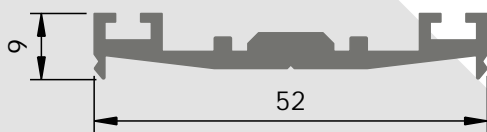

FD - 103

Contracapa

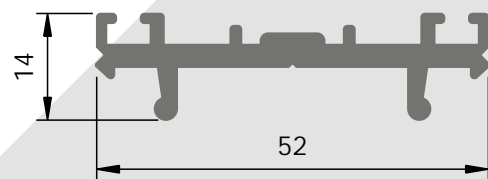

FD - 07

Capa Horizontal

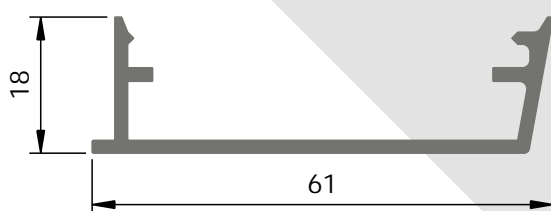

FD - 04

Capa

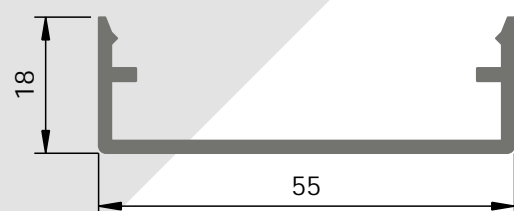

FD - CORTINA

FD - 08
Capa

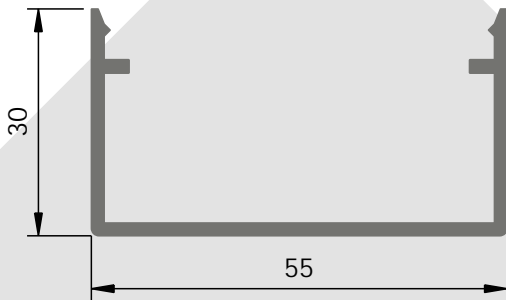

FD - 11
Capa

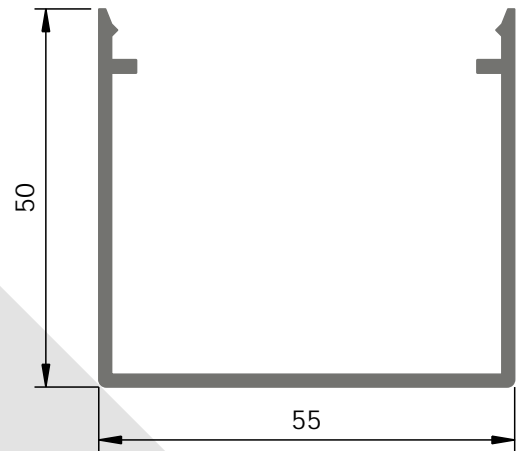

FD - 10
Capa



FD - 82
Capa Redonda

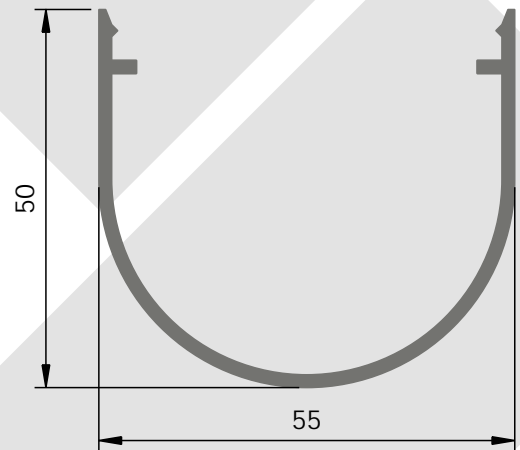

FD - 12
Capa p/ Coberturas

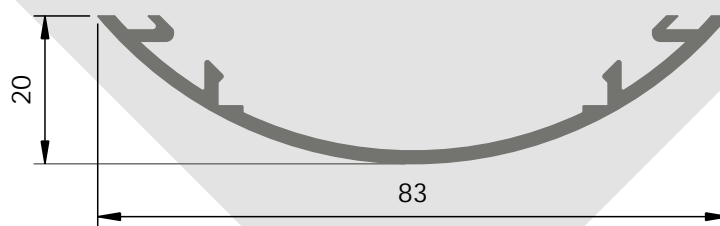

5

FD - CORTINA

FD - 16

Capa Decorativa

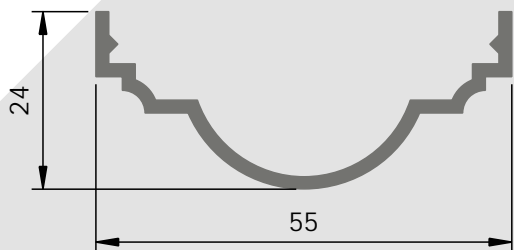

FD - 17

Capa Decorativa

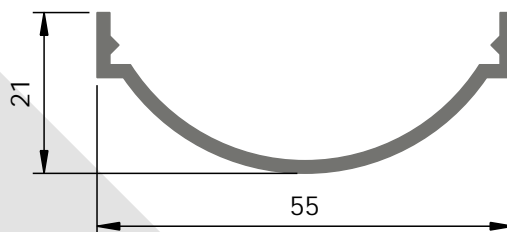

FD - 18

Capa Decorativa

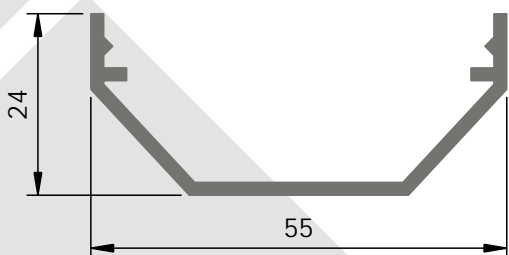

FD - 82

Capa Elíptica

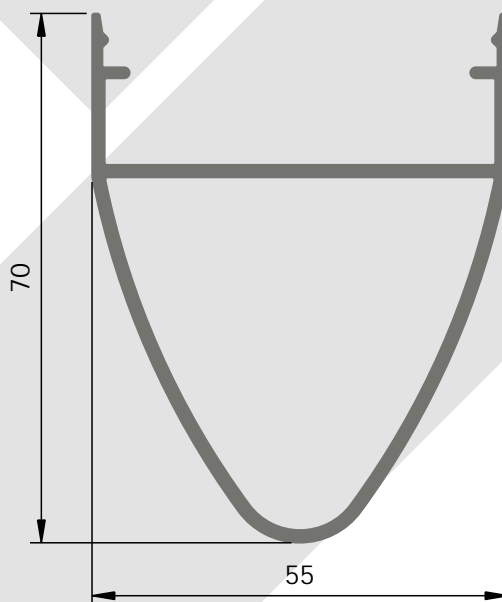

FD - 28

Perfil p/ Ângulo Côncavo

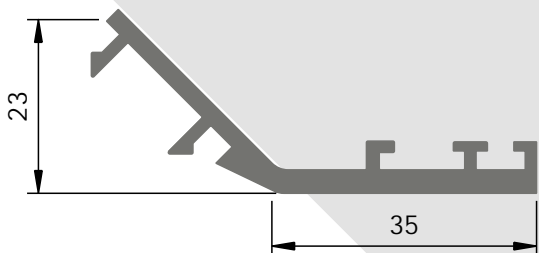

FD - CORTINA

FD - 29

Contracapa p/ Ângulo Côncavo

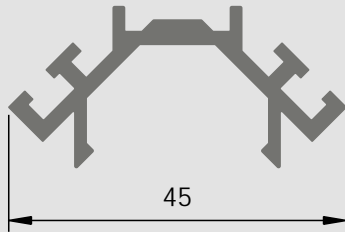

FD - 30

Capa p/ Ângulo Côncavo

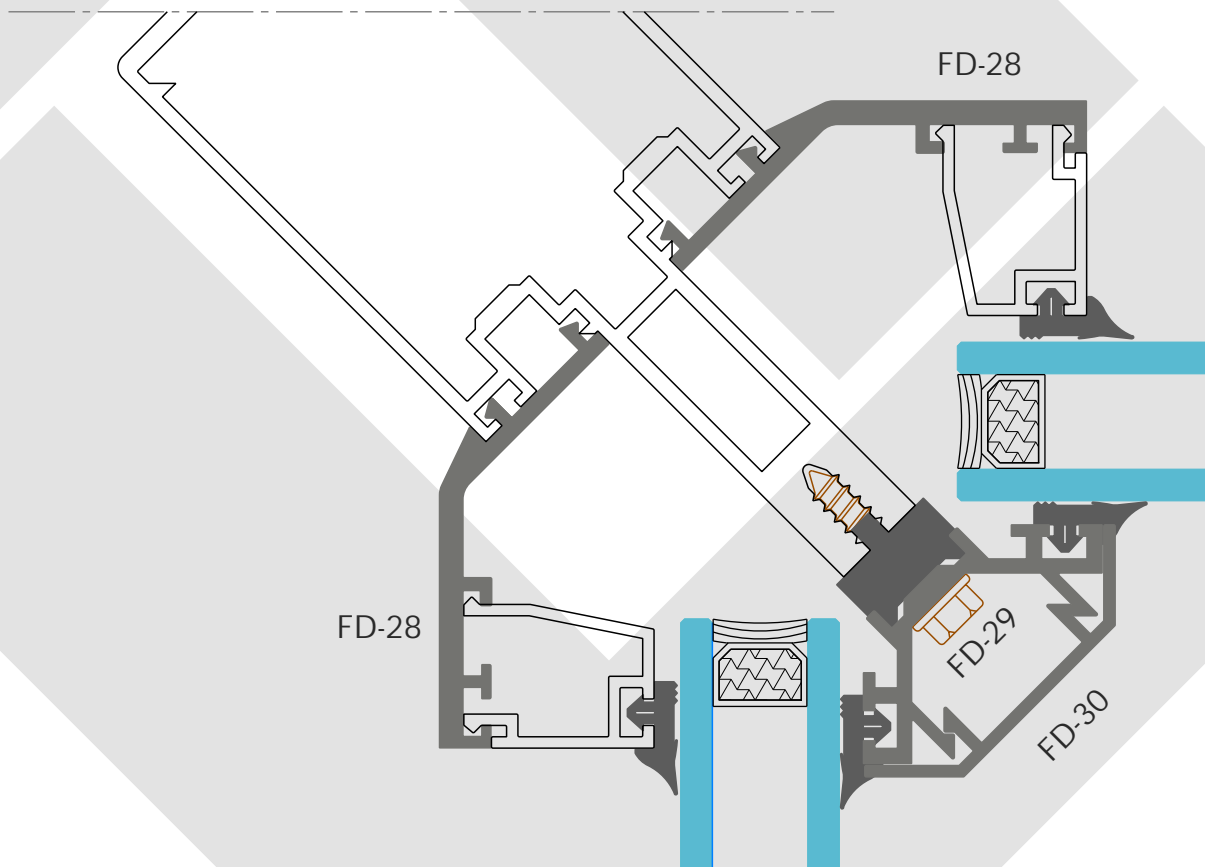

FD - CORTINA

FD - 25
Perfis p/ Ângulos

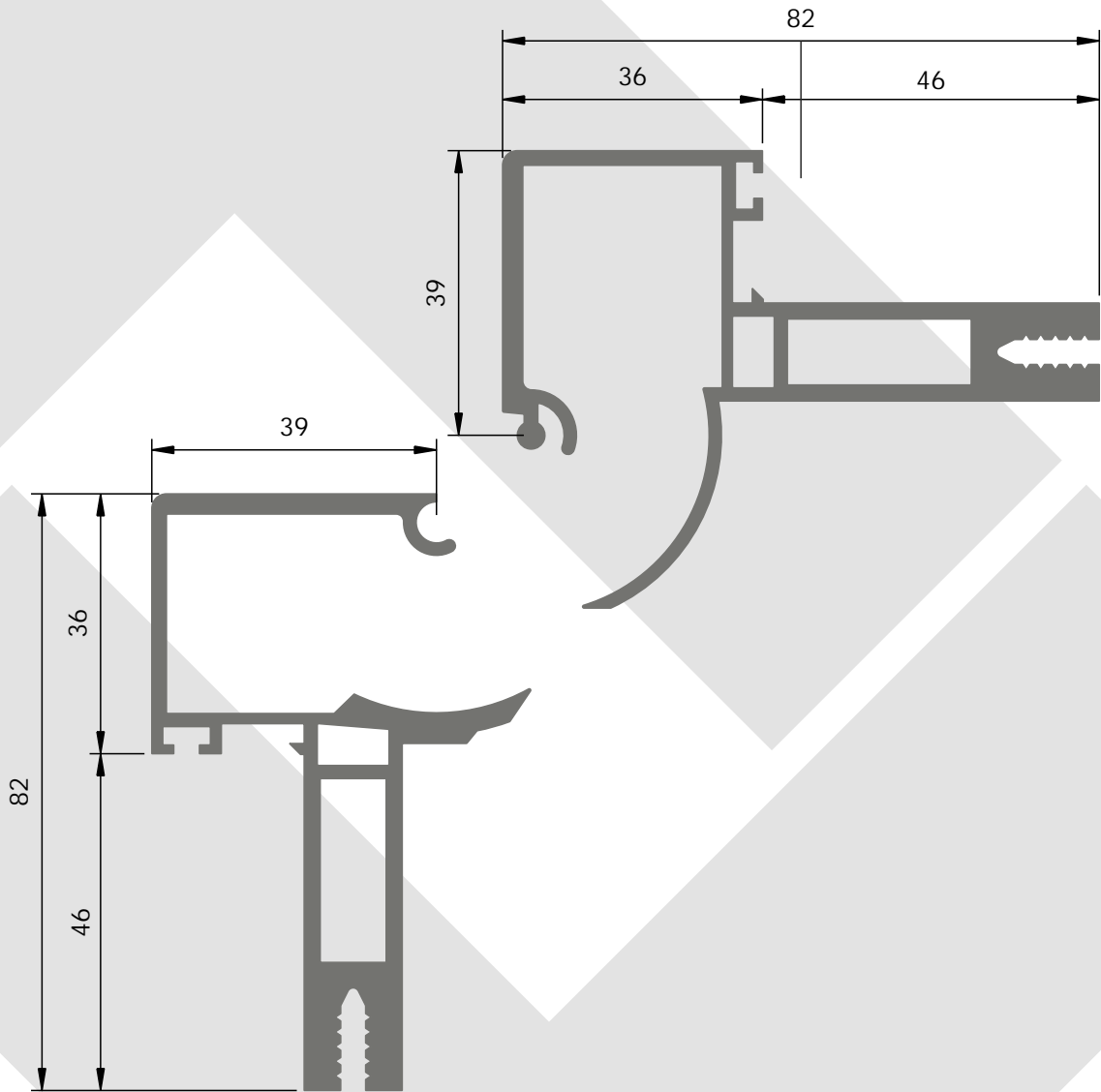

FD - 24
Perfis p/ Ângulos

FD - CORTINA

FD - 31

Perfil p/ Ângulo Convexo

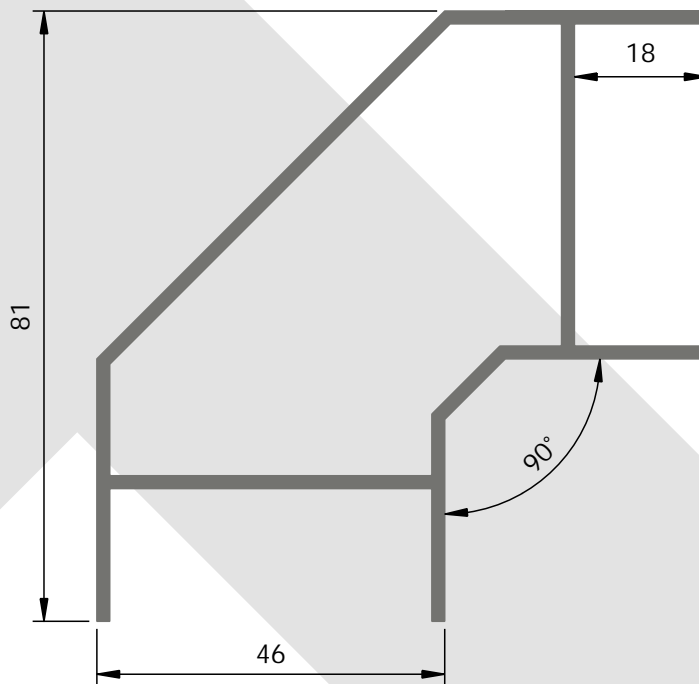

FD - 32

Perfil p/ Ângulos Convexos

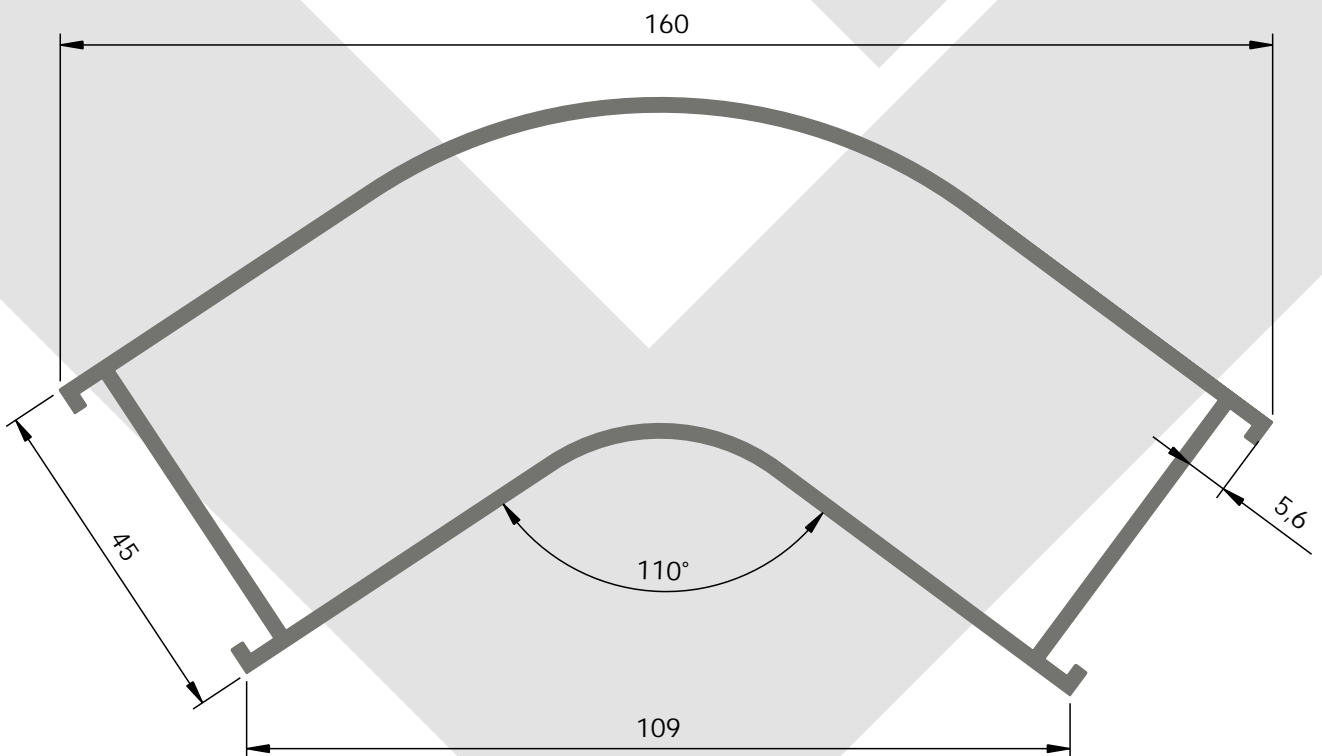

FD - CORTINA

BITES

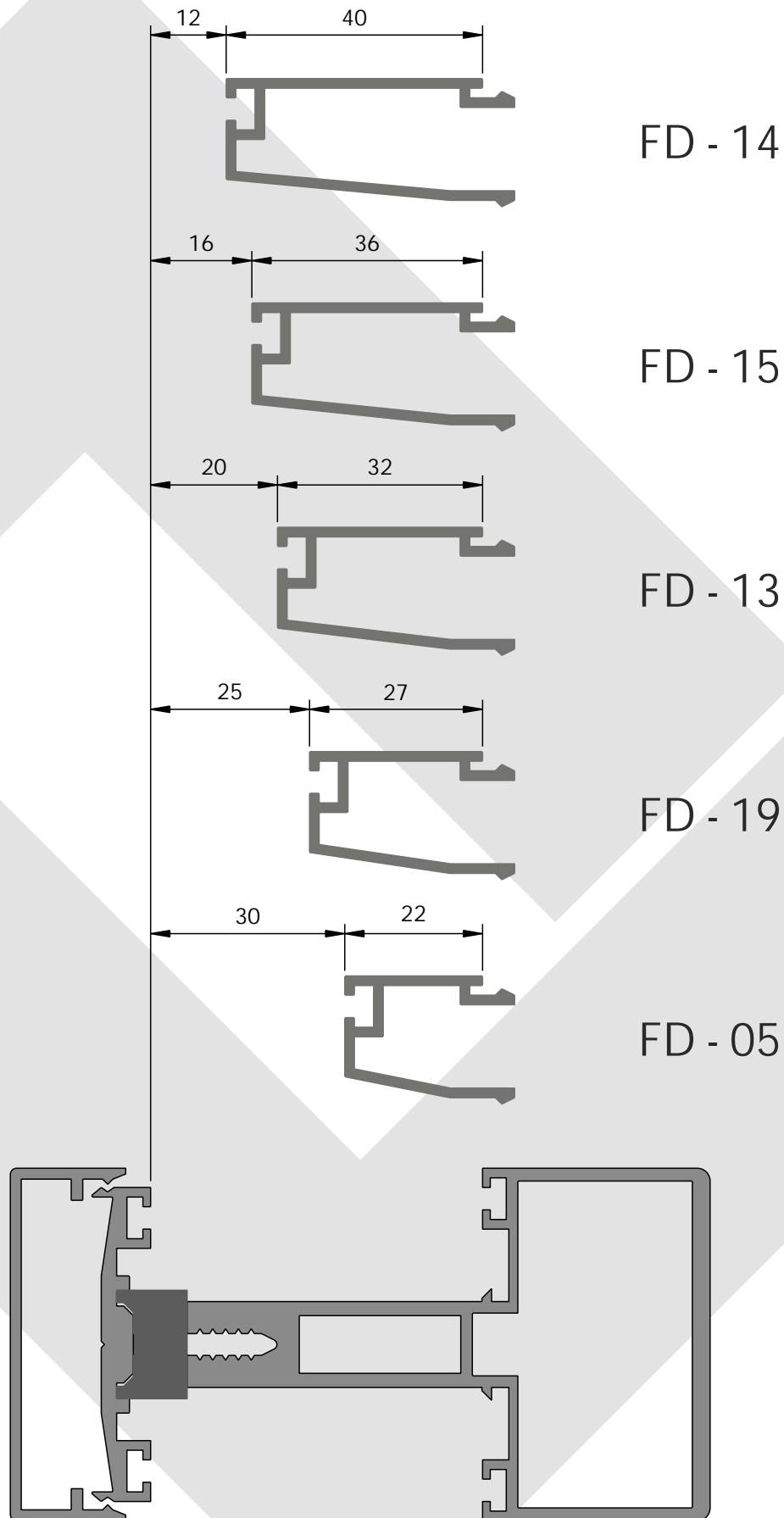

FD - CORTINA

PORMENORES DE MONTAGEM

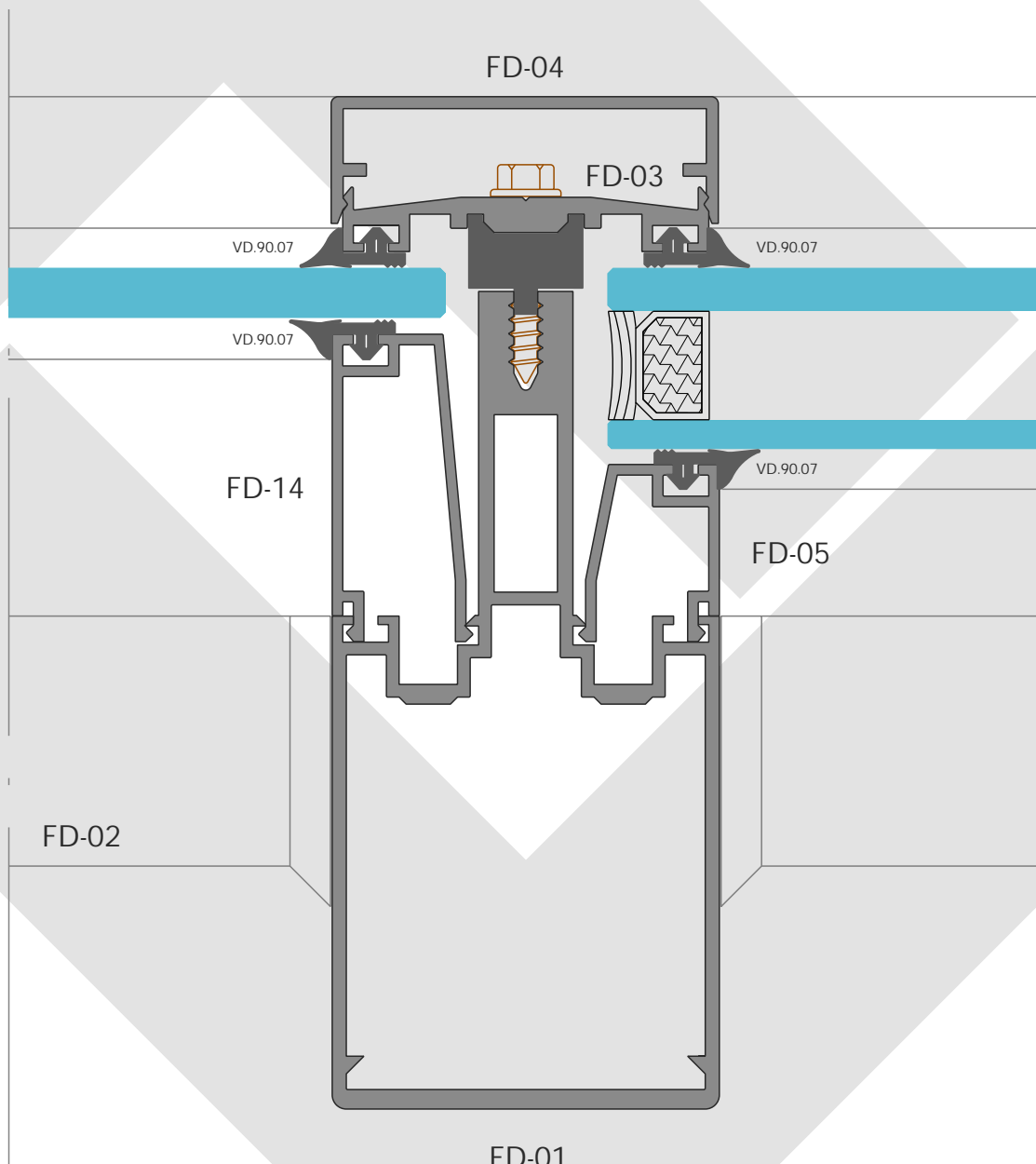
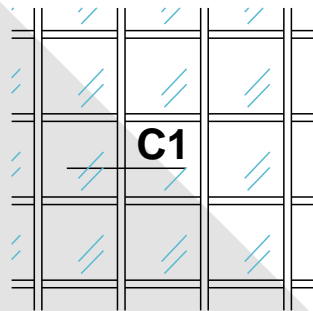

CORTE 1

11

FD - CORTINA

PORMENORES DE MONTAGEM

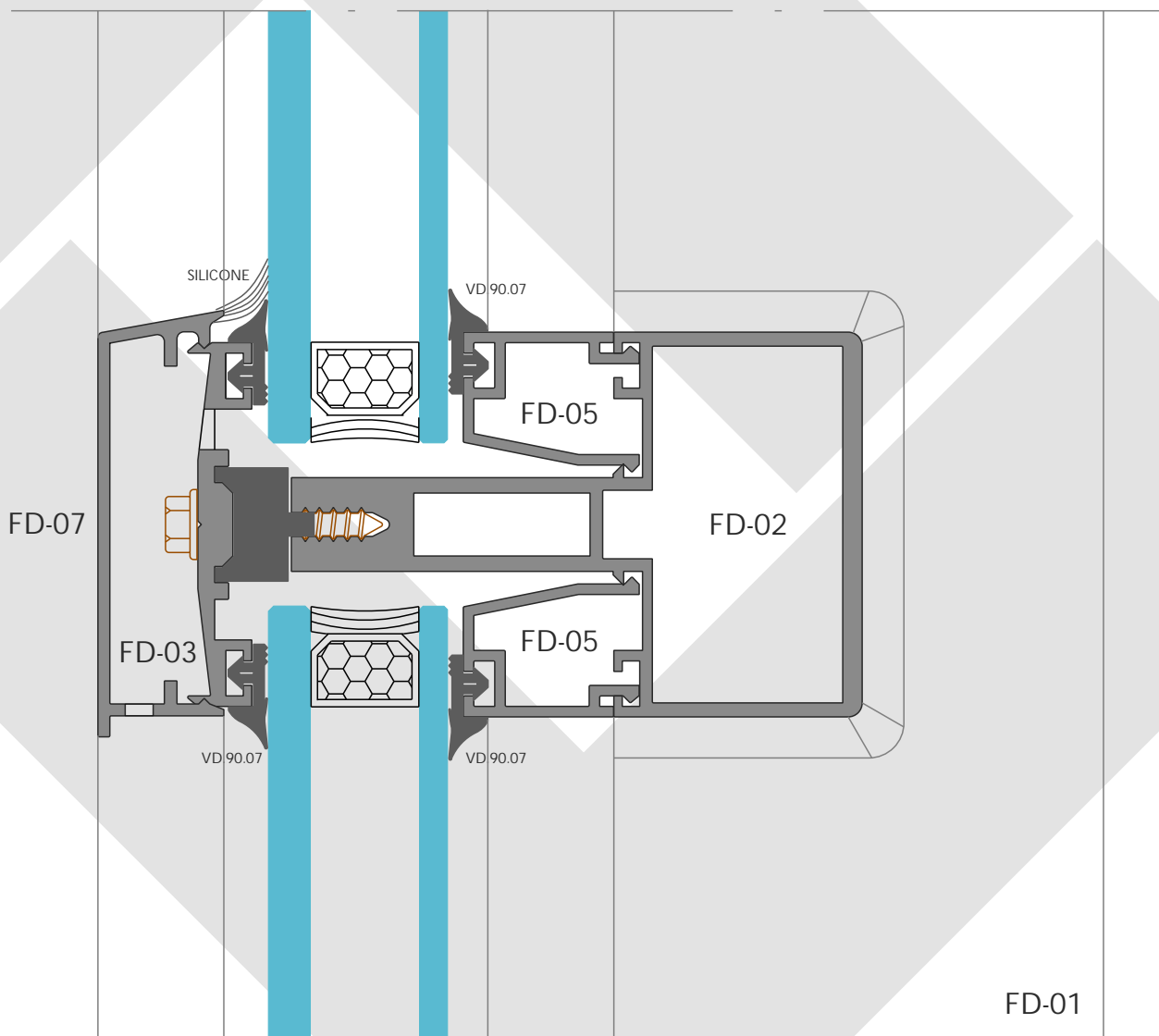
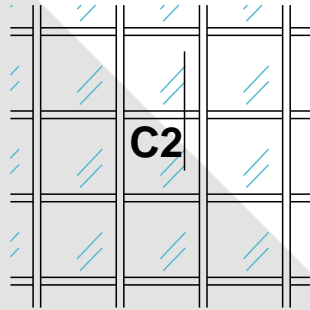

CORTE 2

FD - CORTINA

PORMENORES DE MONTAGEM

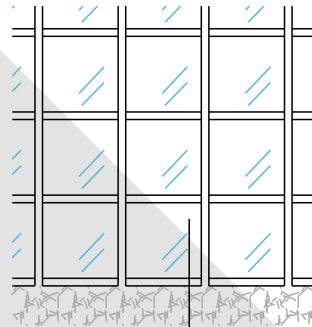

C3

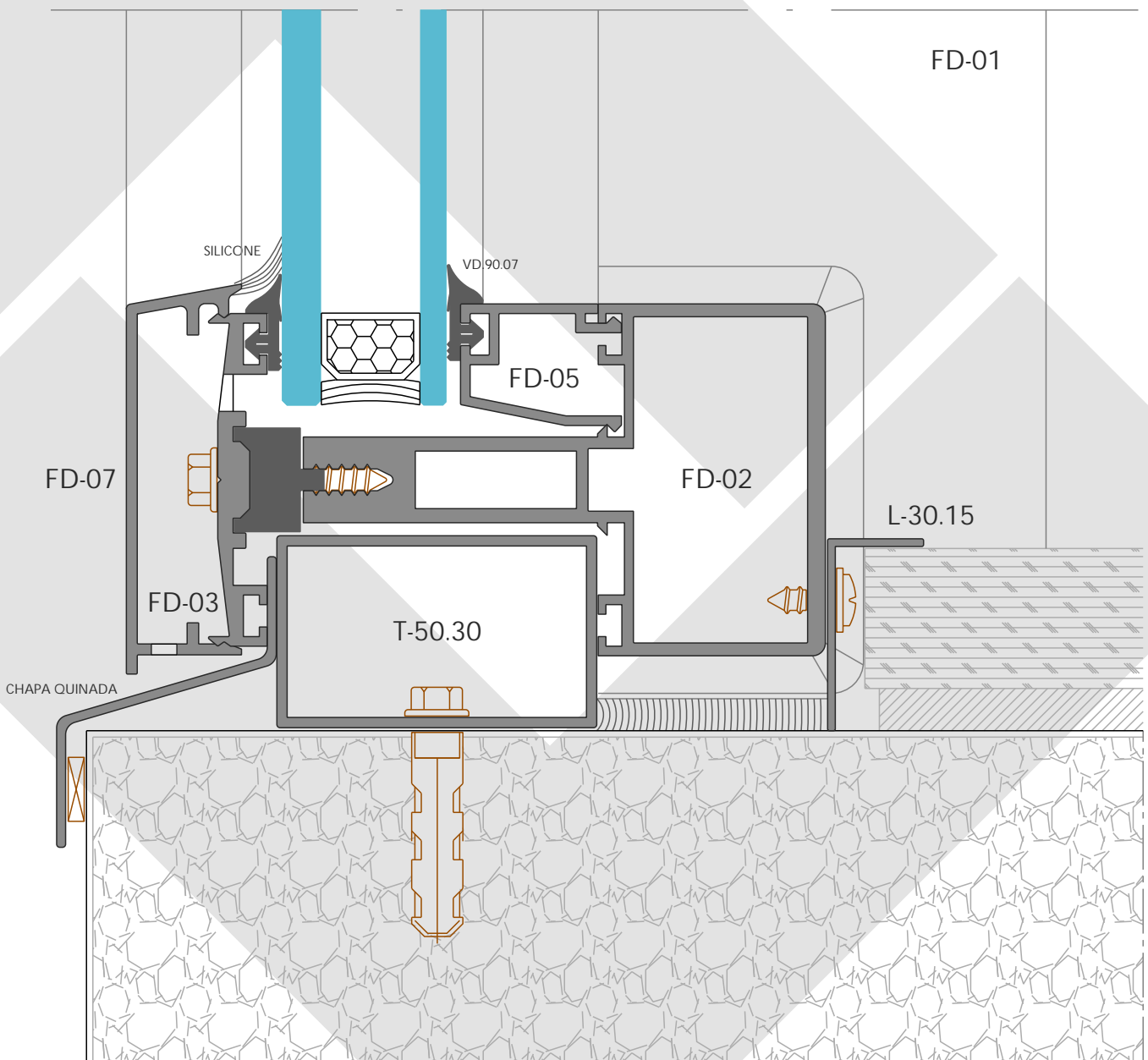

CORTE 3

13

FD - CORTINA

PORMENORES DE MONTAGEM

C4

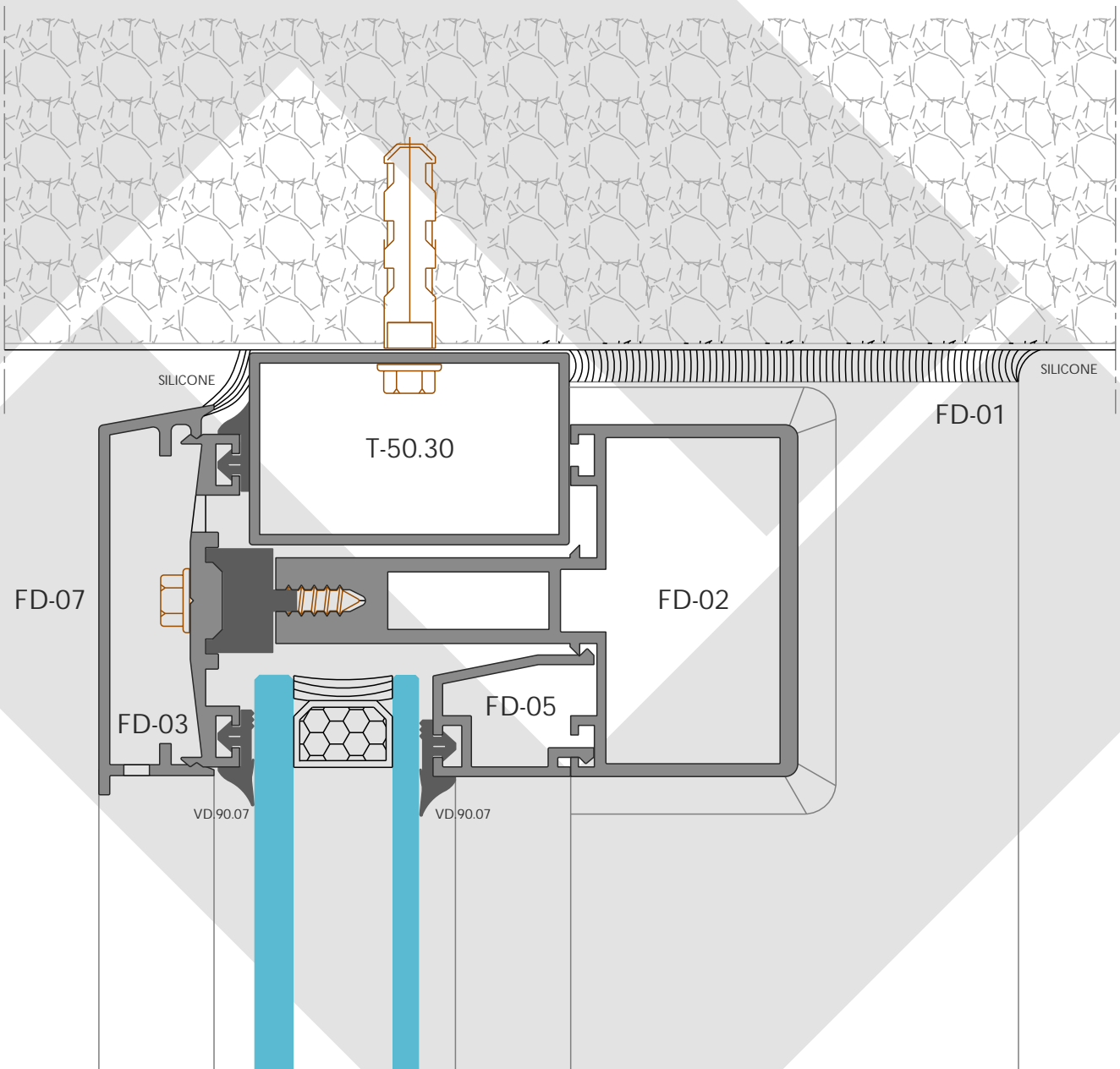
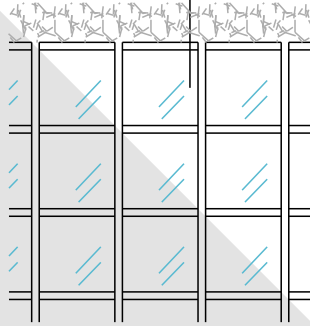

CORTE 4

FD - CORTINA

PORMENORES DE MONTAGEM

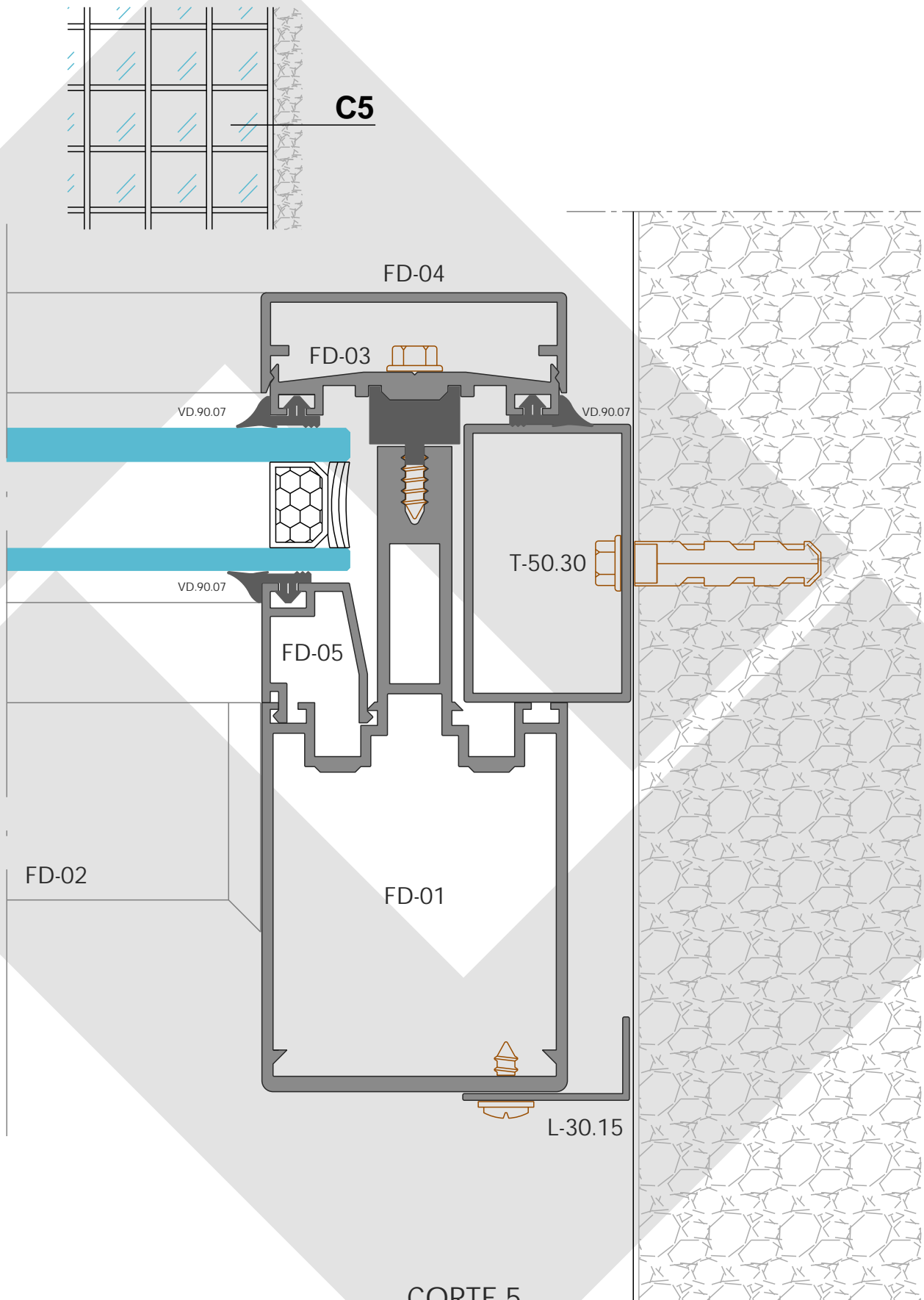

CORTE 5

15

FD - CORTINA

PORMENORES DE MONTAGEM

C6

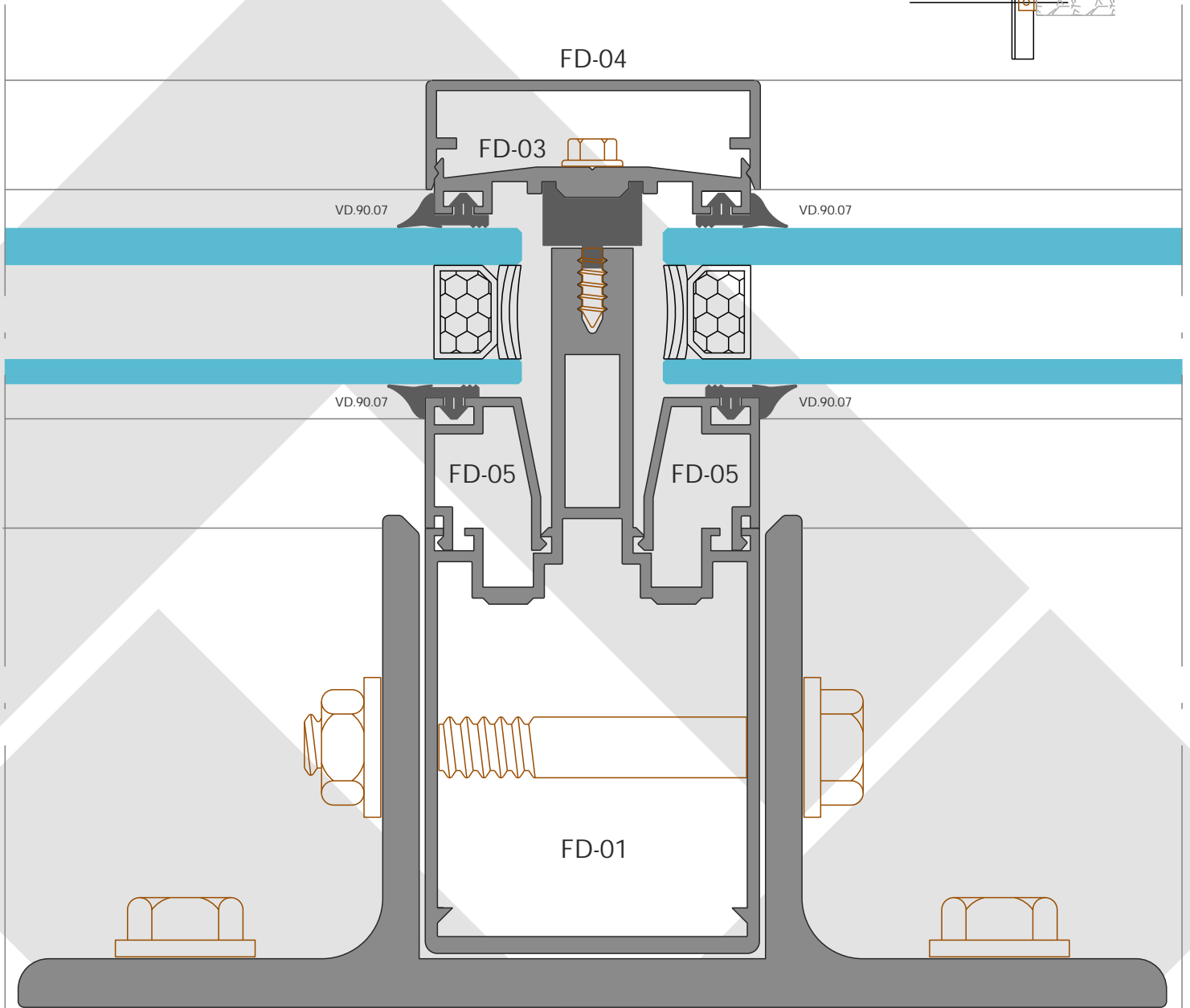
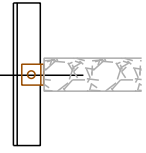

CORTE 6

16

FD - CORTINA

PORMENORES DE MONTAGEM

Ângulo de 90° Convexo

C7

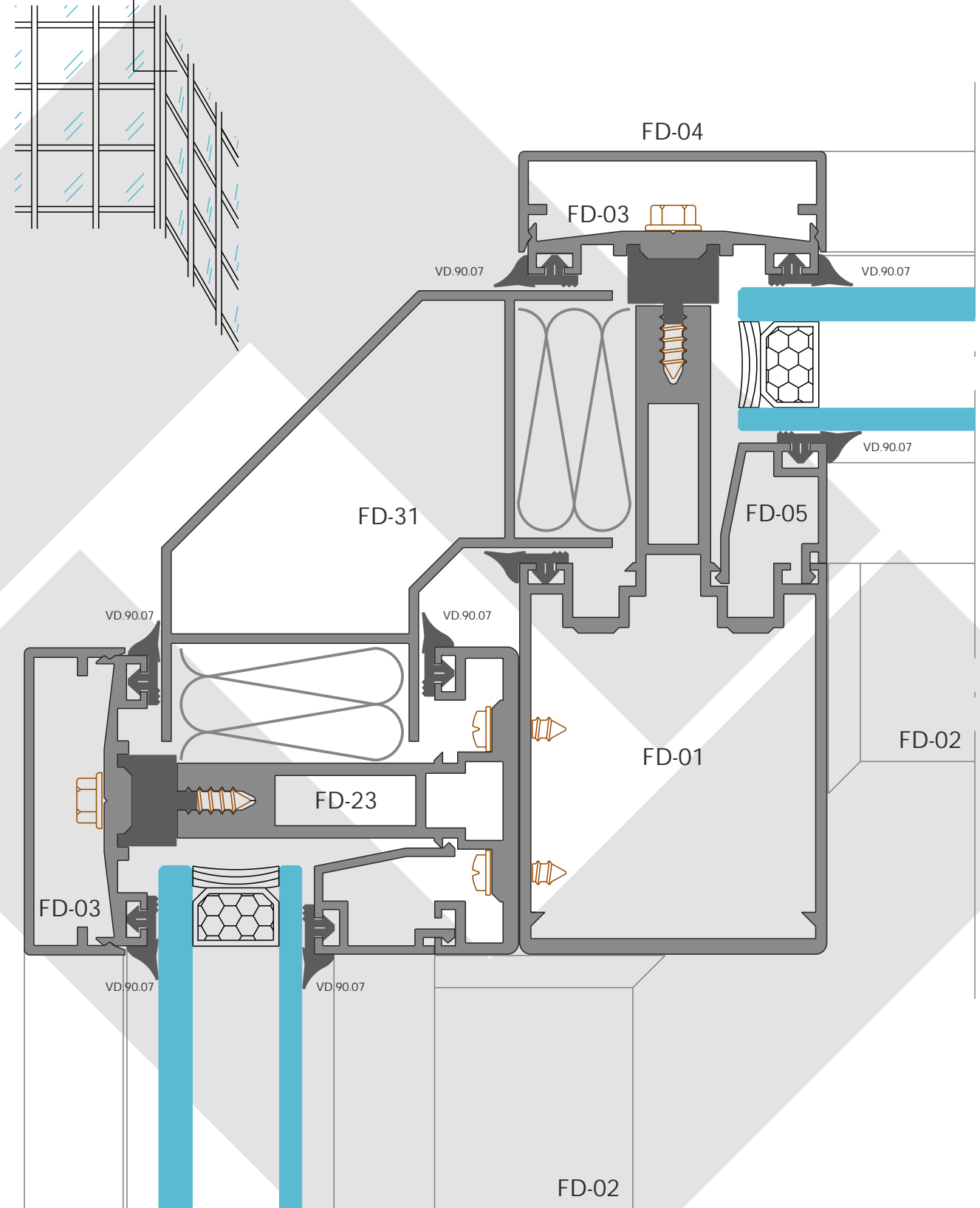

CORTE 7

17

FD - CORTINA

PORMENORES DE MONTAGEM

Ângulo de 90° Côncavo

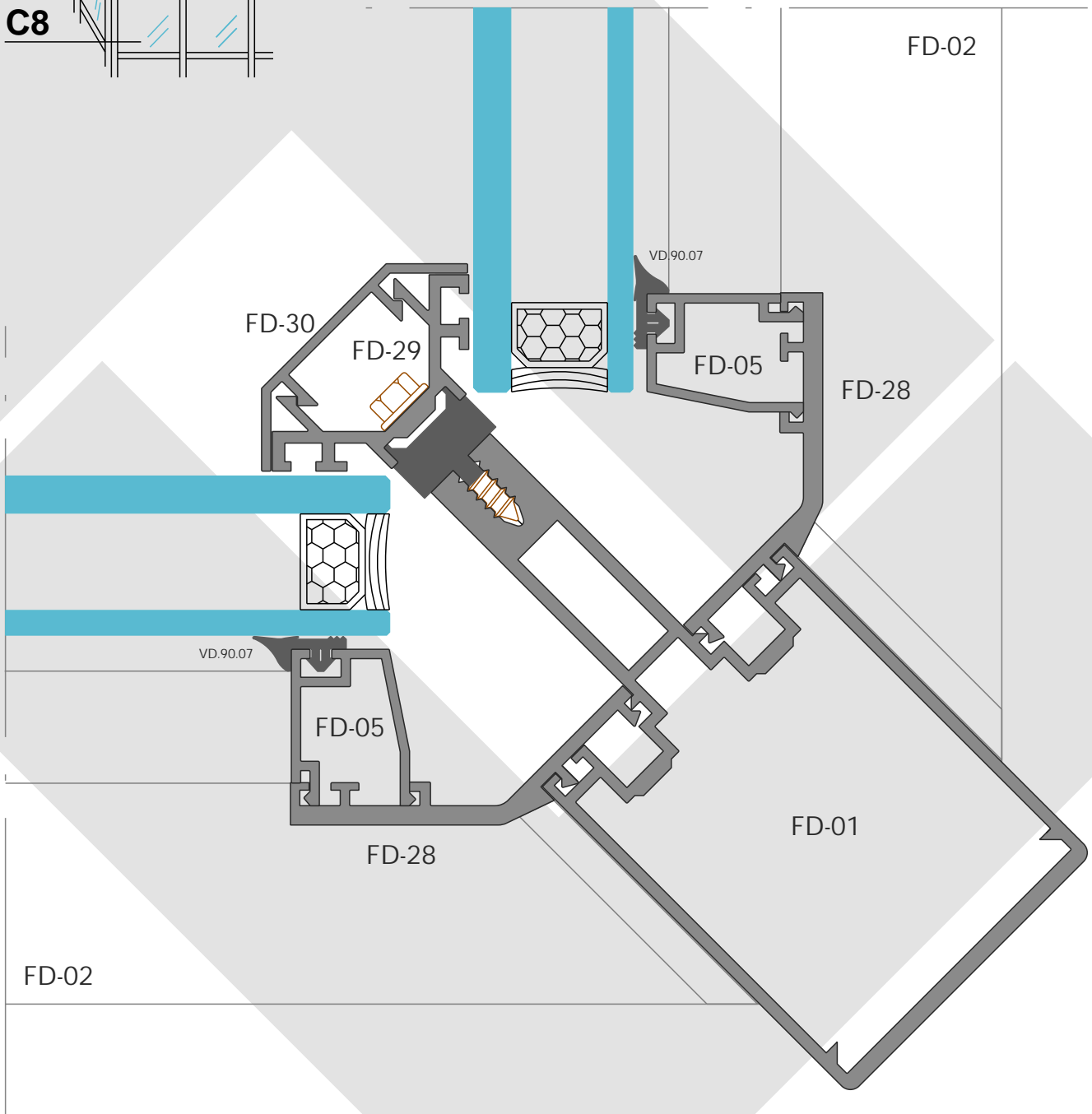
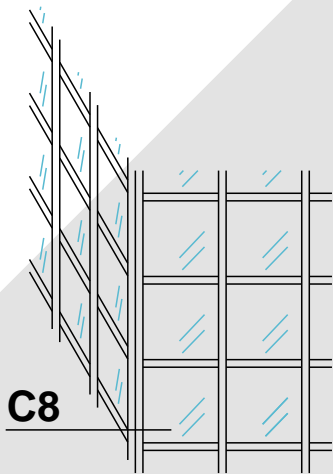

FD - CORTINA

PORMENORES DE MONTAGEM

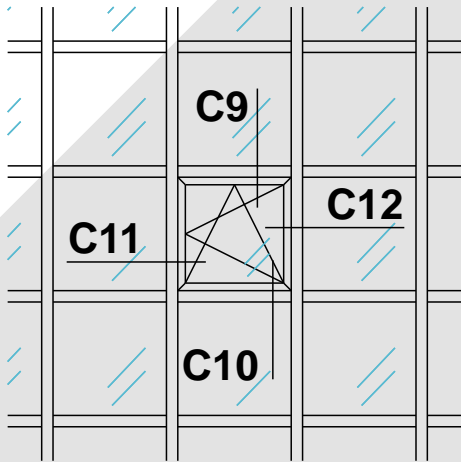

CORTE 9

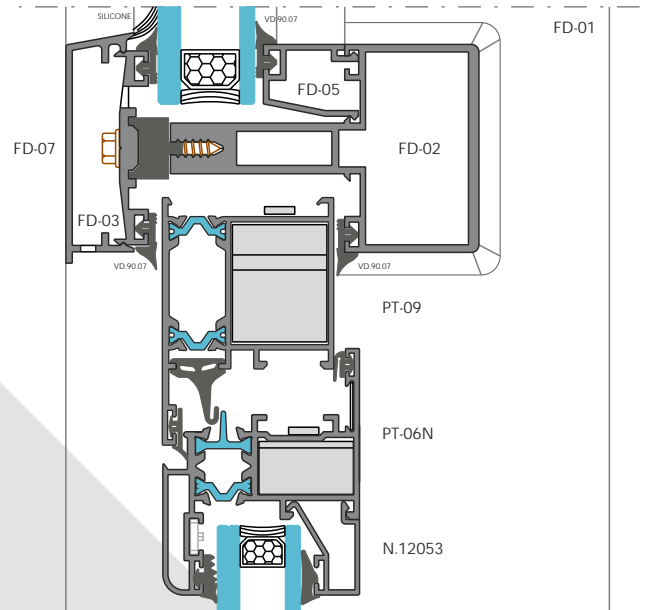

CORTE 10

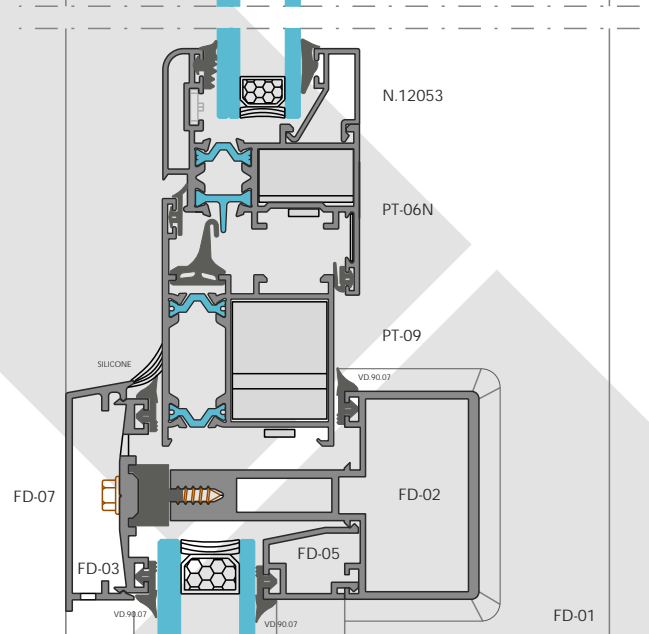

CORTE 11

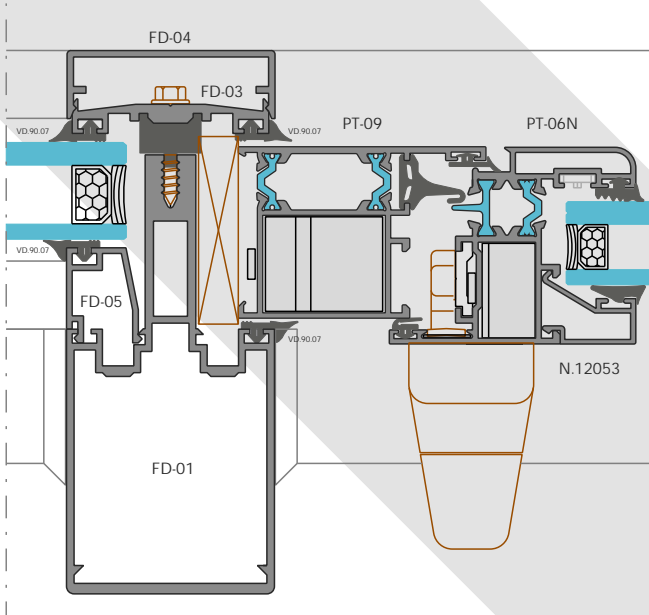

CORTE 12

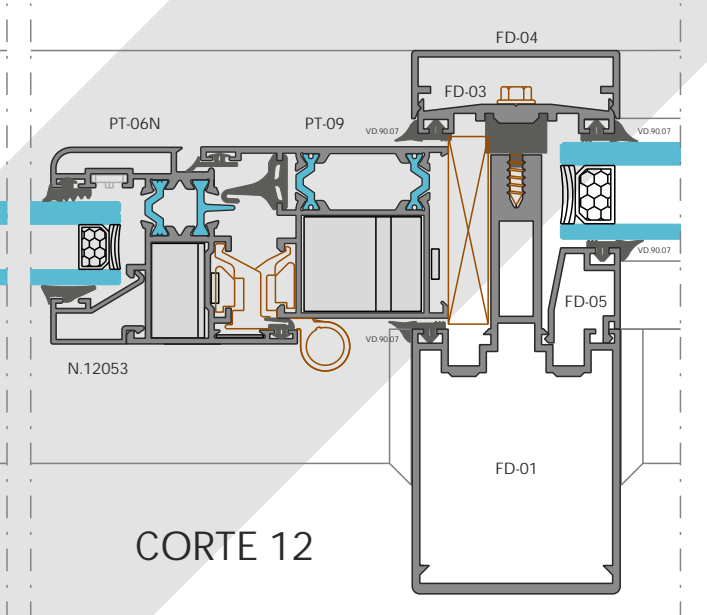

FD - CORTINA

PORMENORES DE MONTAGEM

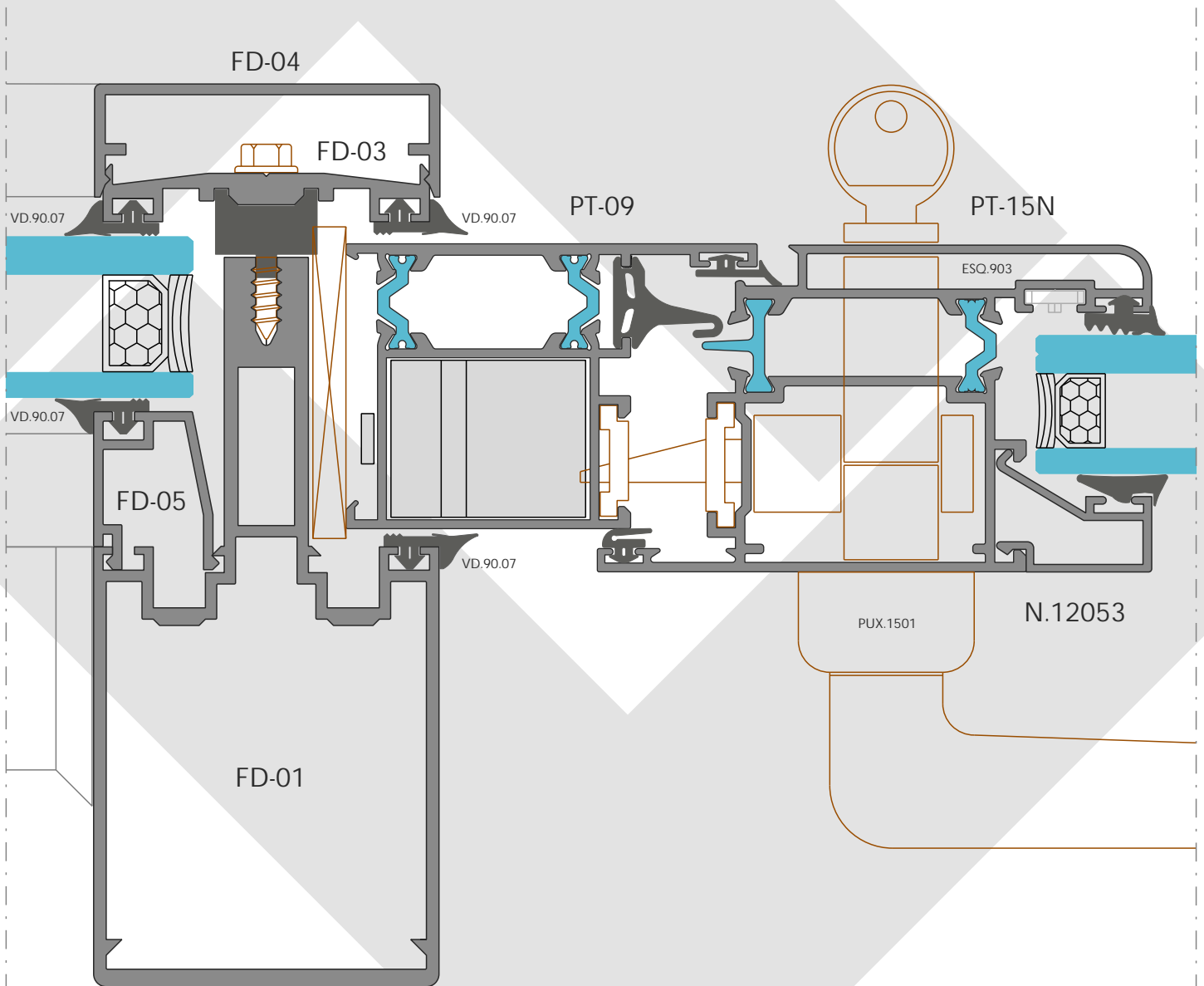
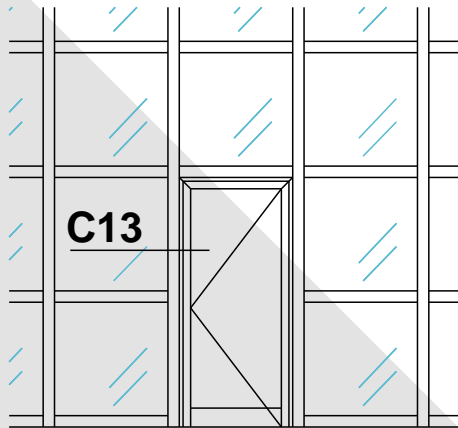

CORTE 13

20

FD - CORTINA

PORMENORES DE MONTAGEM

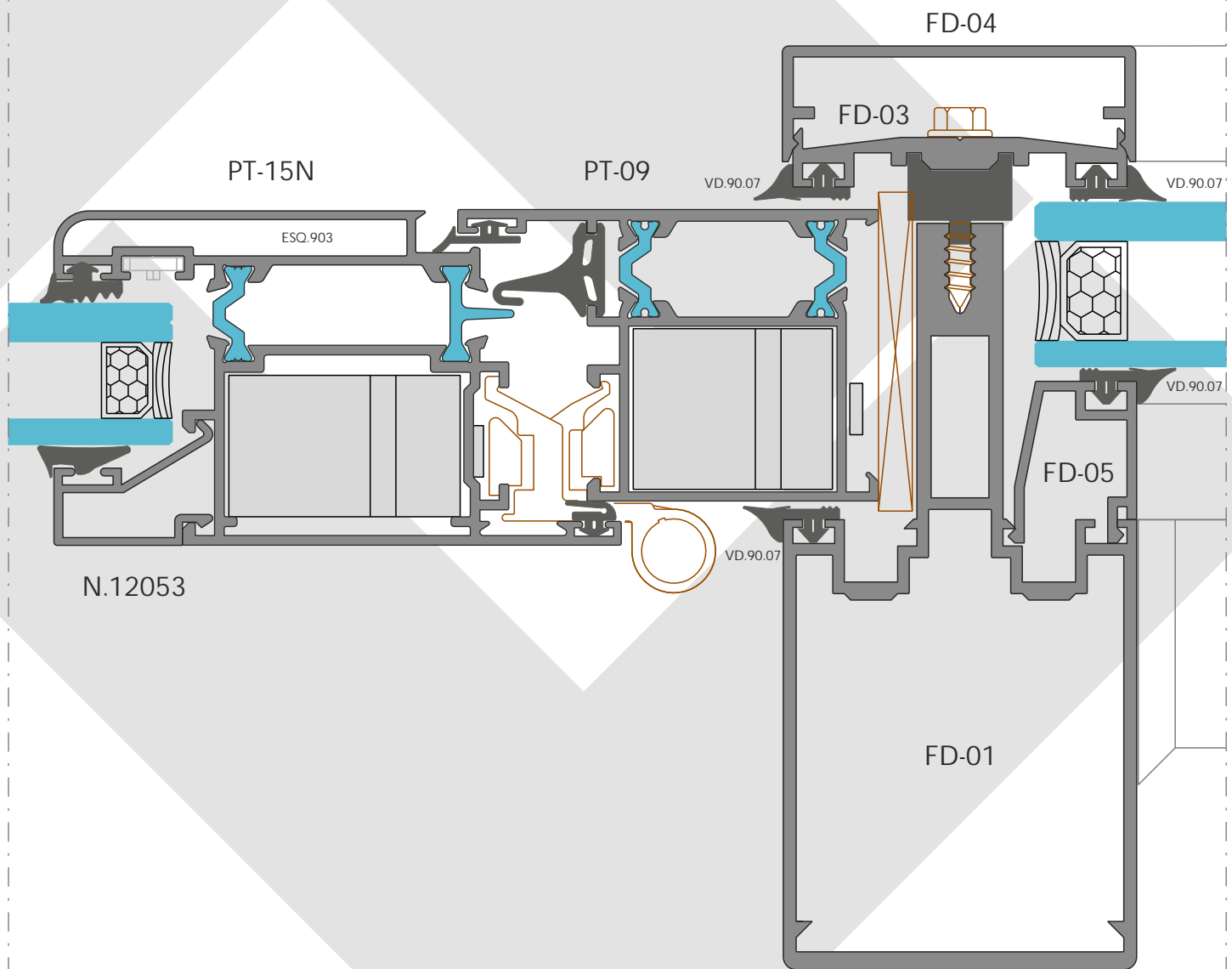
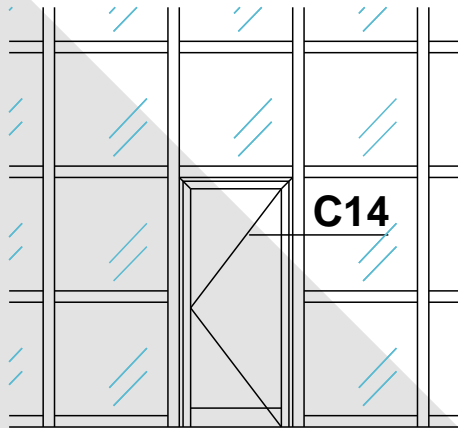

CORTE 14

FD - CORTINA

PORMENORES DE MONTAGEM

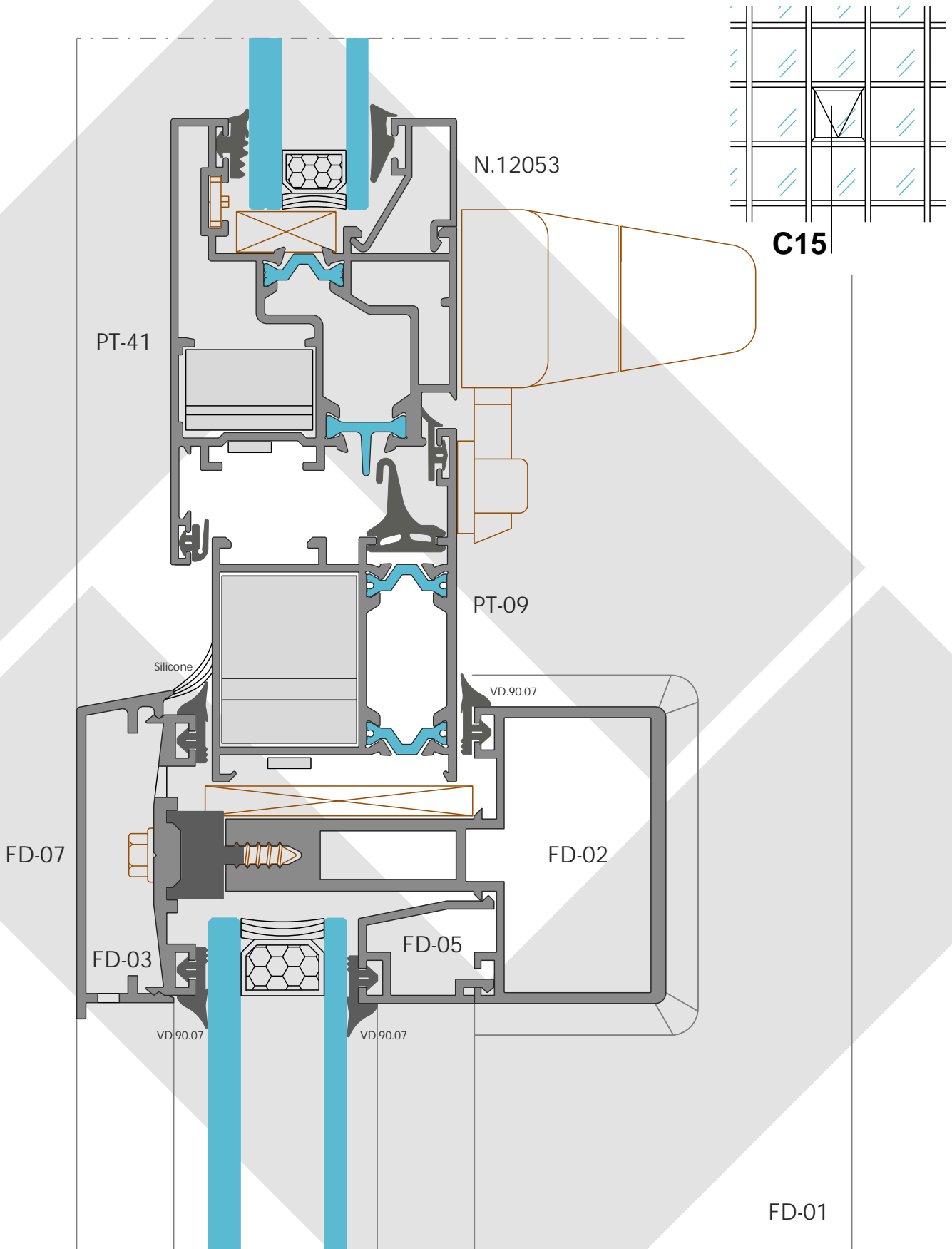

CORTE 15
22

FD - CORTINA

PORMENORES DE MONTAGEM

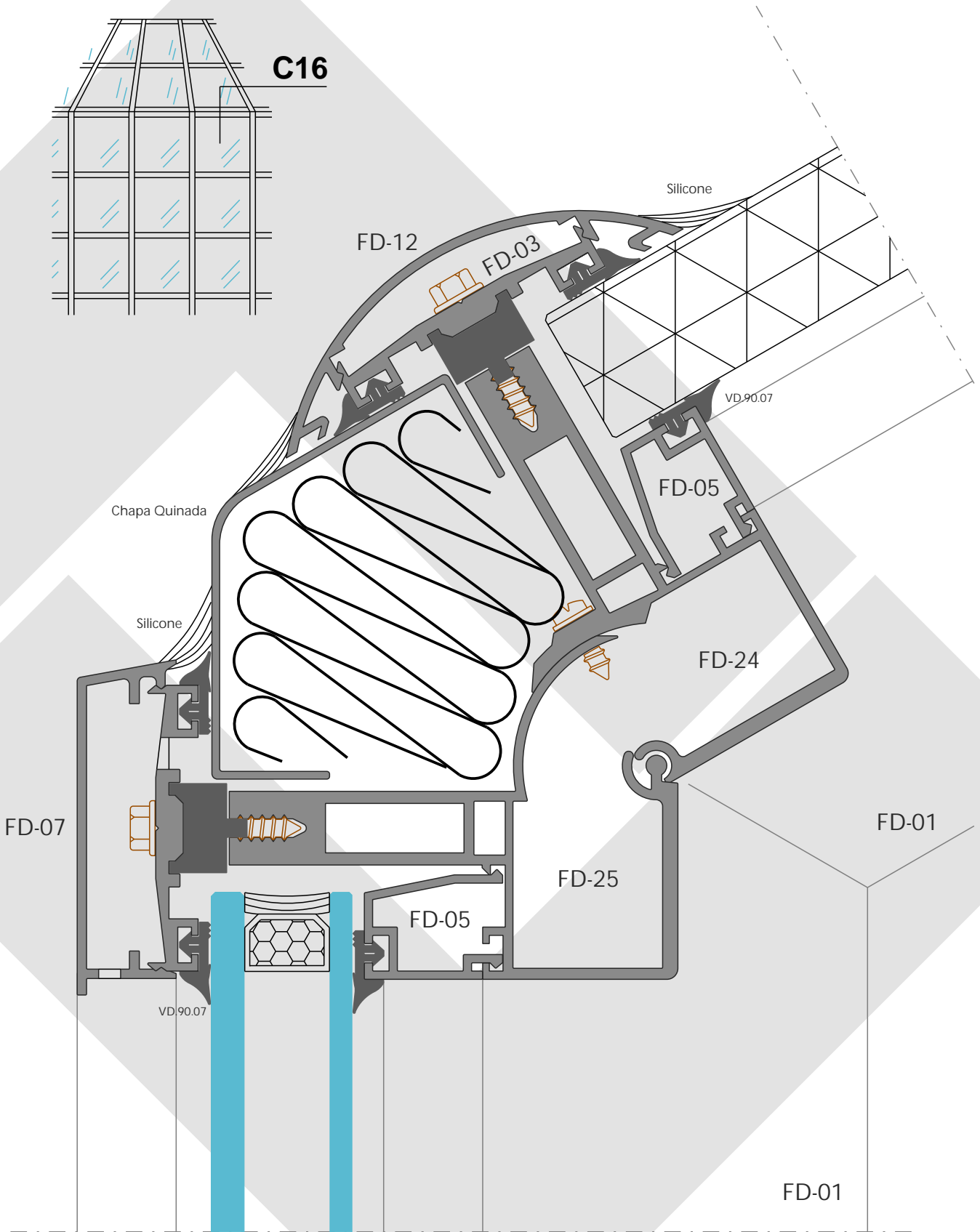

CORTE 14

23

FD - CORTINA

PORMENORES DE MONTAGEM

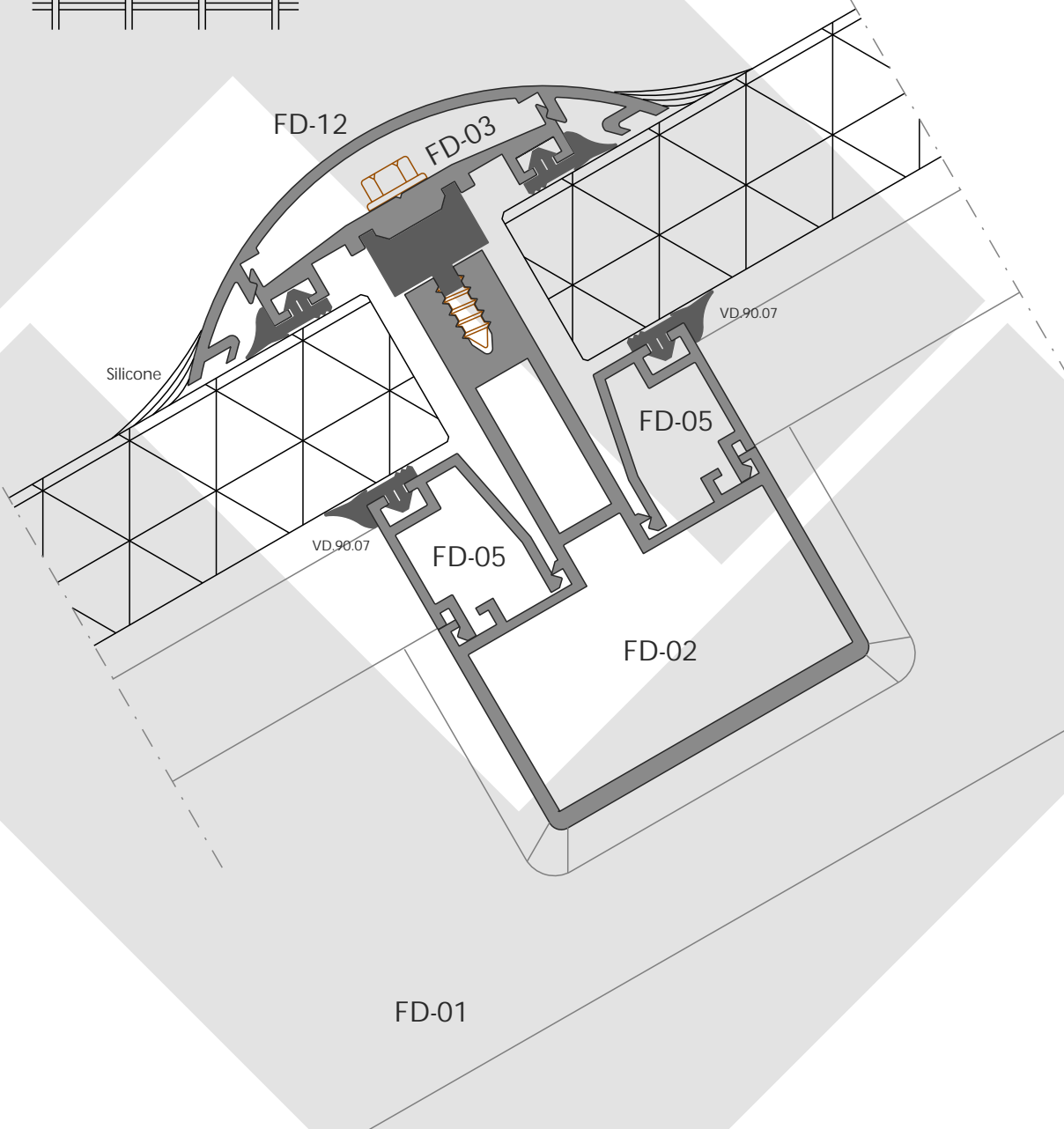
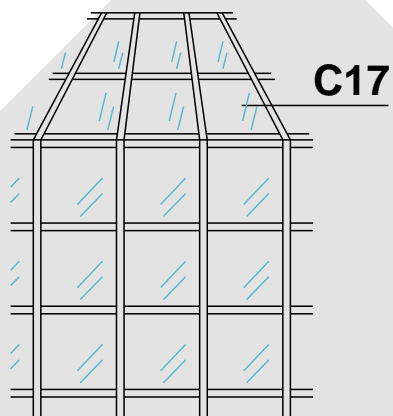

CORTE 17

24

FD - CORTINA

PORMENORES DE MONTAGEM

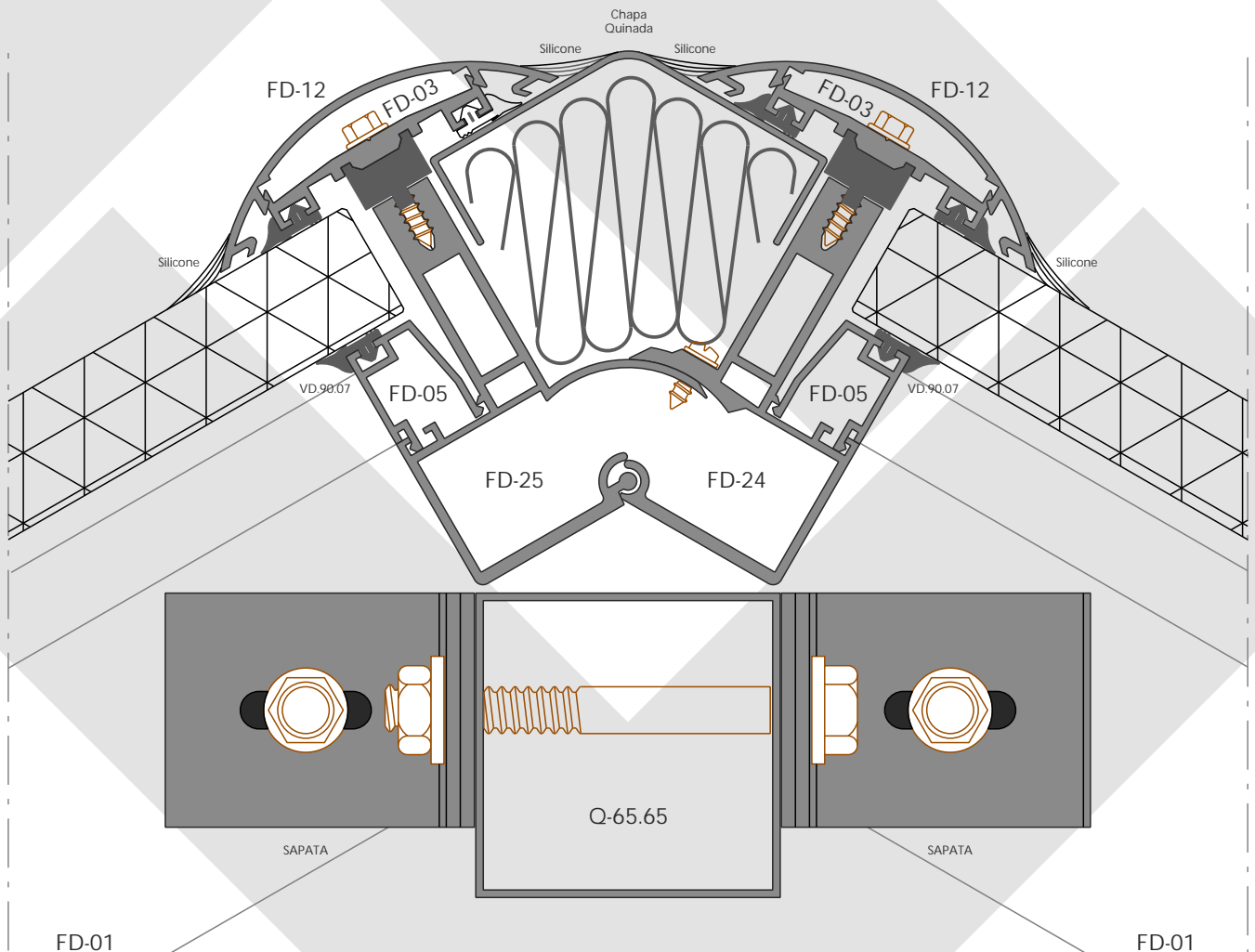
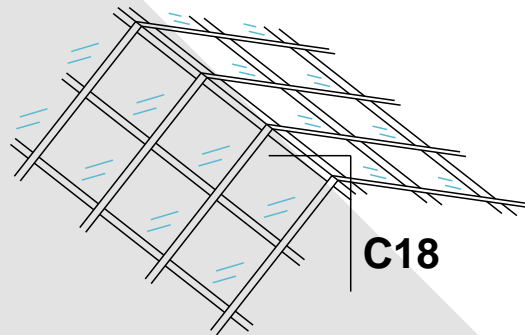

CORTE 18

Escala 1:2

ed. 001

25

FD - CORTINA

ACESSÓRIOS

Características



CÓDIGO: **FK 1007 A**

DESCRIÇÃO: **Peça de alumínio fixação à laje**

UNID. VENDA: **Unidade**

ACABAMENTOS: **Alumínio**

APLICAÇÃO: **Peça para fixar montantes à laje**

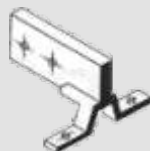

CÓDIGO: **FK 7100**

DESCRIÇÃO: **União travessa fachada zamack**

UNID. VENDA: **Unidade**

ACABAMENTOS: **Zamack**

APLICAÇÃO: **Peça de união da Travessa (FD-02) com os montantes**



CÓDIGO: **FK 830**

DESCRIÇÃO: **Junta de vedação**

UNID. VENDA: **Unidade**

ACABAMENTOS:

APLICAÇÃO: **Junta de estanquidade na união da travessa(FD-02) com o montante**



CÓDIGO: **VD 90-07**

DESCRIÇÃO: **Vedante**

UNID. VENDA: **Rolo**

ACABAMENTOS: **EPDM**

APLICAÇÃO: **Vedante para vidro**



CÓDIGO: **VD 92-01**

DESCRIÇÃO: **Vedante FK tradicional**

UNID. VENDA: **Rolo**

ACABAMENTOS: **EPDM**

APLICAÇÃO: **Vedante para junta interior, sistema tradicional**